

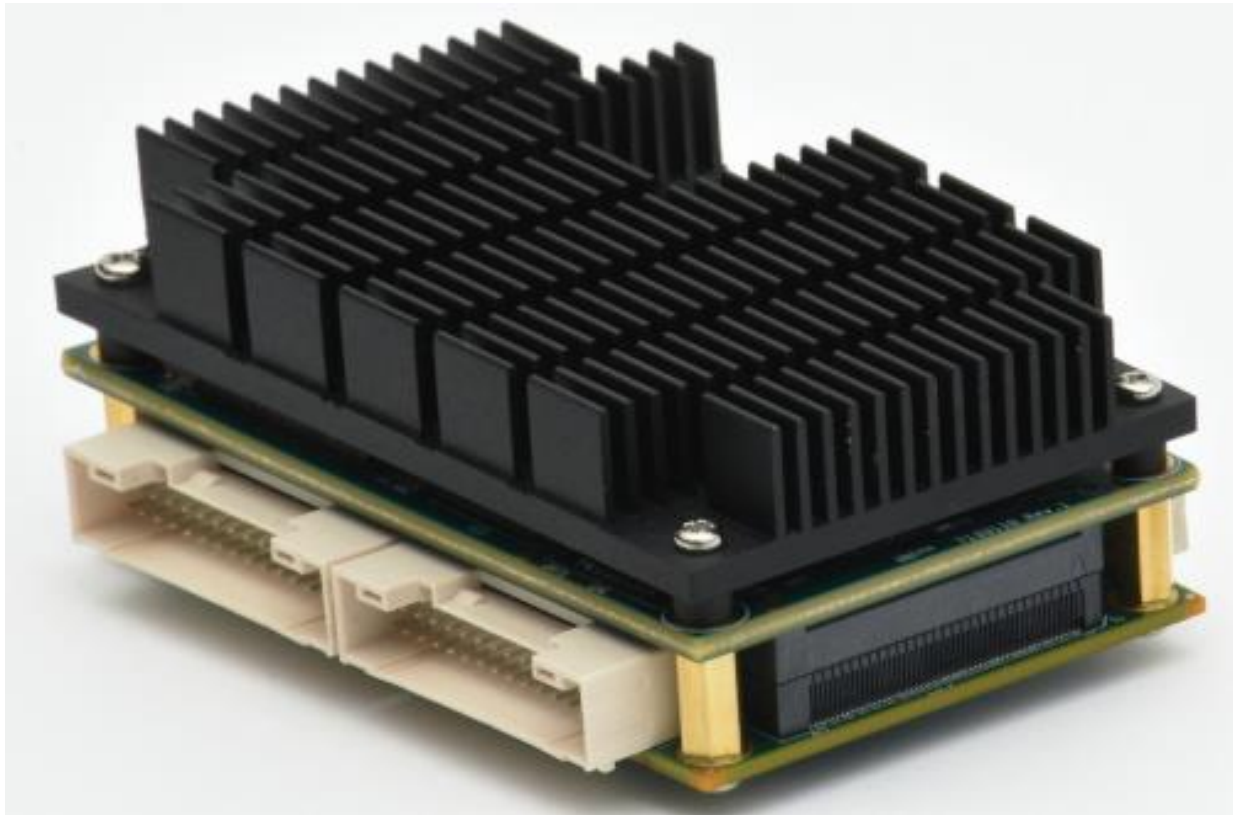

EPSM-10GX User Manual

(with EPS-12000-CM Carrier Board)



Revision	Date	Comments
A.00	06/04/18	Initial Release

**FOR TECHNICAL SUPPORT
PLEASE CONTACT:**

support@diamondsystems.com

© Copyright 2018
Diamond Systems Corporation
158 Commercial Street
Sunnyvale, CA 94086 USA
Tel 1-650-810-2500
Fax 1-650-810-2525
www.diamondsystems.com

CONTENTS

1. Important Safe Handling Information	4
2. Introduction	5
2.1 Description	5
2.2 Features	6
2.2.1 Main Board	6
2.2.2 Carrier Board (EPS-12000-CM)	6
2.2.3 Mechanical and Environmental	6
2.3 Models and Products	7
3. Functional Overview	8
3.1 Functional Block Diagram	8
3.2 Key Subsystems	9
3.2.1 Ethernet Switch	9
3.2.2 Ethernet LEDs	9
3.2.3 Power Supply	9
3.2.4 Serial interface	9
3.2.5 Thermal Solution	9
4. Mechanical Drawing	10
4.1 Main Board	10
4.2 EPS-12000-CM CARRIER BOARD	11
4.3 Main Board and EPS-12000-CM Carrier Board	11
5. Board Layout	12
5.1 Main Board	12
5.2 EPS-12000-CM Carrier Board	13
5.3 Key ICs and Connector List	14
5.3.1 Main Board	14
5.3.2 EPS-12000-CM Carrier Board	14
6. Connector Pinout and Description	15
6.1 MAIN BOARD	15
6.1.1 High-speed B2B connectors (J1, J2)	15
6.2 EPS-12000-CM Carrier Board	21
6.2.1 High-speed B2B connectors (J1, J2)	21
6.2.2 Ethernet Ports (J3, J4, J5)	24
6.2.3 Serial Interface (J6)	24
6.2.4 Power Input (J7)	25
6.2.5 PPS Interface (J6)	25
7. ASSEMBLING/DISASSEMBLING THE CARRIER BOARDS	26
8. Getting Started	28
Web interface and CLI overview	29
9. Using the CLI Interface	29
9.1 Making an Initial Connection	29
9.2 Login/Logout Procedures	29
9.3 Help Utility	30
9.4 Entering Commands	30
9.5 General Command Groups	30
9.5.1 IP Commands	31
9.5.2 MAC Commands	32
9.5.3 VLAN/PVLAN Commands	32
9.5.4 dot1x (IEEE Standard for port-based Network Access Control)	32
9.5.5 LACP Commands	33
9.5.6 LLDP Commands	33
9.5.7 Access Management Commands	34
9.5.8 Access-list Commands	34
9.5.9 Logging Commands	34
9.5.10 Spanning-Tree Commands	35
9.5.11 Green-Ethernet Commands	35
9.5.12 Thermal-protect Commands	36
9.5.13 QoS Commands	36
9.5.14 Privilege Commands	37
9.5.15 SNMP Commands	37

9.5.16	SNTP Commands	38
9.5.17	Radius Server Commands.....	38
9.5.18	Banner Commands	39
9.5.19	Terminal Commands.....	39
9.5.20	Reload.....	39
9.5.21	Firmware Commands.....	39
9.5.22	Ping Commands	40
9.5.23	Debug Commands	40
9.5.24	Security Commands.....	40
9.5.25	Monitor	40
9.5.26	POE.....	40
9.5.27	Examples	41
9.5.28	IP Configuration	41
9.5.29	Port Configuration	41
9.5.30	Change Switch Password.....	41
9.5.31	Set up VLANs	41
9.5.32	SNMP configuration	42
9.5.33	Mirroring.....	42
9.5.34	Setup QoS	43
9.5.35	Firmware Upgrade	43
9.5.36	Factory defaults	43
9.5.1	Board Version Commands.....	43
10.	Using the Web Interface	44
10.1	Examples.....	45
10.1.1	IP configuration	45
10.1.2	Port Configuration	46
10.1.3	Change Switch Password.....	47
10.1.4	Set up VLANs	48
10.1.5	SNMP configuration	50
10.1.6	Mirroring.....	51
10.1.7	Setup QoS	52
10.1.8	Web Interface Activation / Deactivation	53
10.1.9	Firmware upgrade.....	53
10.1.10	Save Startup configuration.....	54
10.1.11	Factory defaults	55
11.	Heat Sink Accessory	56
	Specifications	57

1. IMPORTANT SAFE HANDLING INFORMATION



WARNING!

ESD-Sensitive Electronic Equipment

Observe ESD-safe handling procedures when working with this product.

Always use this product in a properly grounded work area and wear appropriate ESD-preventive clothing and/or accessories.

Always store this product in ESD-protective packaging when not in use.

Safe Handling Precautions

The EPSM-10Gx board contains a high density connector with many connections to sensitive electronic components. This creates many opportunities for accidental damage during handling, installation and connection to other equipment. The list here describes common causes of failure found on boards returned to Diamond Systems for repair. This information is provided as a source of advice to help you prevent damaging your Diamond (or any vendor's) boards.

ESD damage – This type of damage is usually almost impossible to detect, because there is no visual sign of failure or damage. The symptom is that the board eventually simply stops working, because some component becomes defective. Usually the failure can be identified and the chip can be replaced. To prevent ESD damage, always follow proper ESD-prevention practices when handling computer boards.

Damage during handling or storage – On some boards we have noticed physical damage from mishandling. A common observation is that a screwdriver slipped while installing the board, causing a gouge in the PCB surface and cutting signal traces or damaging components.

Another common observation is damaged board corners, indicating the board was dropped. This may or may not cause damage to the circuitry, depending on what is near the corner. Most of our boards are designed with at least 25 mils clearance between the board edge and any component pad, and ground / power planes are at least 20 mils from the edge to avoid possible shorting from this type of damage. However these design rules are not sufficient to prevent damage in all situations.

A third cause of failure is when a metal screwdriver tip slips, or a screw drops onto the board while it is powered on, causing a short between a power pin and a signal pin on a component. This can cause overvoltage / power supply problems described below. To avoid this type of failure, only perform assembly operations when the system is powered off.

Sometimes boards are stored in racks with slots that grip the edge of the board. This is a common practice for board manufacturers. However our boards are generally very dense, and if the board has components very close to the board edge, they can be damaged or even knocked off the board when the board tilts back in the rack. Diamond recommends that all our boards be stored only in individual ESD-safe packaging. If multiple boards are stored together, they should be contained in bins with dividers between boards. Do not pile boards on top of each other or cram too many boards into a small location. This can cause damage to connector pins or fragile components.

Power supply wired backwards – Our power supplies and boards are not designed to withstand a reverse power supply connection. This will destroy each IC that is connected to the power supply (i.e. almost all ICs). In this case the board will most likely will be unrepairable and must be replaced. A chip destroyed by reverse power or by excessive power will often have a visible hole on the top or show some deformation on the top surface due to vaporization inside the package. **Check twice before applying power!**

Overvoltage on analog input – If a voltage applied to an analog input exceeds the design specification of the board, the input multiplexor and/or parts behind it can be damaged. Most of our boards will withstand an erroneous connection of up to $\pm 36V$ on the analog inputs, even when the board is powered off, but not all boards, and not in all conditions.

Overvoltage on analog output – If an analog output is accidentally connected to another output signal or a power supply voltage, the output can be damaged. On most of our boards, a short circuit to ground on an analog output will not cause trouble.

Overvoltage on digital I/O line – If a digital I/O signal is connected to a voltage above the maximum specified voltage, the digital circuitry can be damaged. On most of our boards the acceptable range of voltages connected to digital I/O signals is 0-5V, and they can withstand about 0.5V beyond that (-0.5 to 5.5V) before being damaged. However logic signals at 12V and even 24V are common, and if one of these is connected to a 5V logic chip, the chip will be damaged, and the damage could even extend past that chip to others in the circuit.

2. INTRODUCTION

2.1 Description

The EPSM-10GX is a managed Layer 2+ Ethernet switch module in an ultra-compact 2.2" x 3.3" (55 x 84mm) size offering 24 10/100/1000Mbps copper ports + 2 10Gbps SFI ports. The module is intended to be used on a carrier board. There are two variant carrier boards available for EPSM-10GX module.

- **EPS-12000-CM:** 12-port Gigabit Ethernet switch with 12 copper ports
- **EPS-24G2X:** 26-port Gigabit Ethernet switch with 24 copper ports and 2 SFP+ ports

Note: This document provides the details about working with **EPS-12000-CM** carrier board. Please refer to **EPS-24G2X User Manual** for working with **EPS-24G2X** carrier board.

Highly Advanced Gigabit Ethernet Switch

EPSM-10GX is based on the Vitesse VSC7444 24+2 port Gigabit Ethernet switch chip. The main board provides VSC7444 Switch + VSC8522 PHY in COM Express mini form factor. The main board offers 2x 10G SFP+, 12x GbE, 3x QSGMII interfaces over two high speed board to board connectors.

Layer 2+ Managed Switch

EPSM-10GX offers all layer 2 functionality, all layer 3 functionality but routing, and some layer 4 functionality. It includes a built-in microcontroller for configuration and management that can be accessed either through the on-board RS-232 port or one of the Ethernet ports.

Carrier Boards

The EPSM-10GX is intended to be used on a carrier board. Two configurations are available for carrier board

- A 12-port copper Gigabit Ethernet switch
- A full version 26-port Gigabit Ethernet switch with 24 copper ports and 2 SFP+ sockets

Note: This document provides the details about working with **EPS-12000-CM** carrier board. Please refer to **EPS-24G2X User Manual** for working with **EPS-24G2X** carrier board.

Wide Power DC/DC Power Supply

EPSM-10GX is powered through +5V DC. When used with the EPS-12000-CM carrier board, wide range of input power supply of +7V to 34V DC/DC is supported.

Rugged Design

Extended temperature operation of -40°C to +85°C is tested and guaranteed. EPSM-10GX comes standard with a thermal heat sink for cooling. A heat sink accessory is also available.

Software Support

The EPSM-10GX switch is ready to plug into your application without any driver installation or firmware upgrades. All firmware comes pre-loaded on the Epsion-10GX switch. A web interface provides an intuitive GUI for configuring and managing the switch. A command line interface is also available for managing the switch over an RS-232 port.

2.2 Features

2.2.1 Main Board

- ◆ Vitesse VSC7444 Ethernet switch with a built-in 500MHz MIPS CPU
- ◆ Vitesse VSC8522 12 port Gigabit PHY
- ◆ 2x 10Gbps SFI interface
- ◆ Programmable flash on the board

2.2.2 Carrier Board (EPS-12000-CM)

- ◆ Provides 12 10/100/1000 copper ports (derived from VSC8522 12 port Gigabit PHY on main board)
- ◆ 12 on board magnetics
- ◆ Three latching I/O connectors with four Ethernet ports per connector
- ◆ Power Input connector; +7V to +34V
- ◆ Serial input connector

2.2.3 Mechanical and Environmental

- ◆ **Main Board**
 - ◆ COM Express mini form factor, 2.165" W x 3.307" H/ 84mm x 55mm
 - ◆ +5 VDC power input
 - ◆ -40°C to +85°C ambient operating temperature

- ◆ **Carrier Board: EPS-12000-CM**
 - ◆ COM Express mini form factor, 2.165" W x 3.307" H/ 84mm x 55mm
 - ◆ +7 VDC to +34VDC power input
 - ◆ -40°C to +85°C ambient operating temperature

2.3 Models and Products

<i>Model Number</i>	<i>Description</i>
EPSM-10GX	26-Port Managed Gigabit Ethernet Switch module, COM Express mini form factor, -40°C to +85°C operating temperature
EPS-12000-CM	12x 10/100/1000 Mbps Gbe copper ports, +7V DC to 34V DC power supply range. -40°C to +85°C operating temperature
Cable Kit:	
6981508	Quad Ethernet cable-3 Nos
6981507	Power cable
6981050	Serial cable

3. FUNCTIONAL OVERVIEW

3.1 Functional Block Diagram

EPSM-10GX is a Layer 2+ managed Ethernet switch with built-in microcontroller and memory for configuration and management. The flash memory holds dual application images along with the boot code. The NOR Flash holds the configuration parameters.

An RS-232 interface is provided to enable communication between the on-board management microcontroller and a host processor through a command line interface (CLI). The microcontroller is also accessible through one of the Ethernet ports via a web management interface.

Power is provided through the +7V-+34VDC wide-range DC power supply, enabling use with industrial power sources.

Figure 1 below provides an overview of the key functional blocks of the EPS-12000-CM Ethernet switch, comprising of the EPSM-10GX main module and 12 port carrier board.

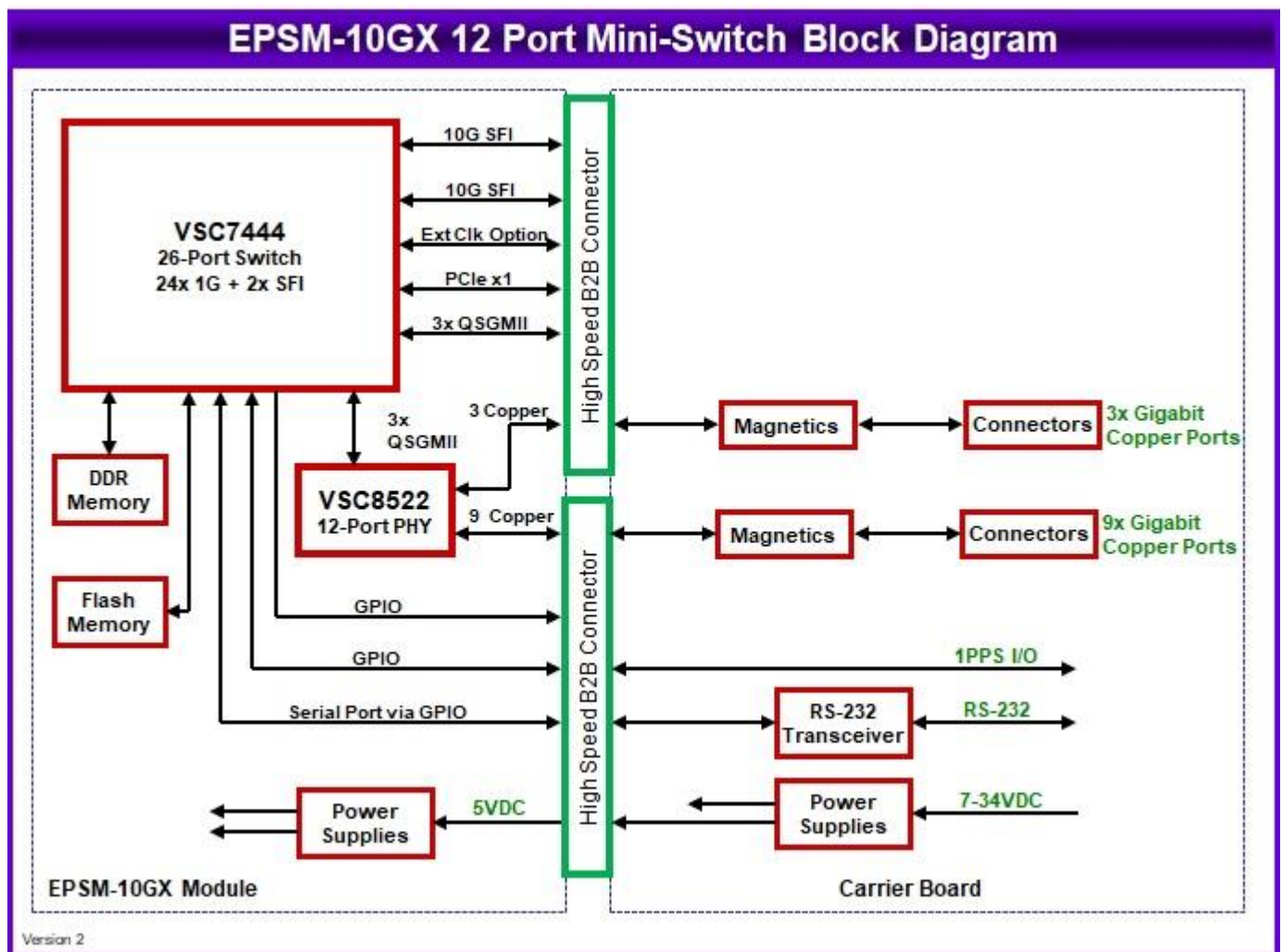

Figure 1 Functional Block Diagram of EPS-12000-CM (EPSM-10GX with 12 port carrier board)

3.2 Key Subsystems

3.2.1 Ethernet Switch

EPSM-10GX is based on the Microsemi VSC7444 6 × QSGMII ports + 2 × 10G SFI ports gigabit switch. The chip contains 2 × SERDES10G lanes interface for 2 SFIs. VCore-III™ CPU system with integrated 500 MHz MIPS 24KEc CPU with MMU and DDR3/DDR3L SDRAM controller. The chip contains a built-in processor that runs layer 2 and layer3 management software provided by Microsemi. The code is stored in on-board flash memory and is upgradeable via Ethernet or serial interface.

Main board with the VSC7444 + VSC8522 PHY chip supports 2 × 10G SFI ports+ 12 1G ports+ 3 × QSGMII ports.

The EPS-12000-CM carrier board provides 12 10/100/1000 copper ports, derived from EPSM-10GX module. A carrier board is installed on the bottom of the main board. Carrier board has 12 on board magnetics and 3 latching connectors, each supporting four copper ports. Power and communication between the two boards is achieved via a pair of high speed board to board connectors.

3.2.2 Ethernet LEDs

All LED signals from EPSM-10GX module are brought to the high-speed connectors through serial bus. The EPS-12000-CM carrier board does not provide on board LEDs to indicate the port status.

3.2.3 Power Supply

EPS-12000-CM is powered by a +7VDC to +34VDC wide range power supply. Carrier board uses 4pin latching power input connector (J7). The power input is protected with a transorb to prevent over voltage on the input. +5V power supply output provides an indicator LED to verify that the output is working properly. The power supply ground is not connected directly to chassis ground. The board mounting holes and any heat sink mounting holes are not connected directly to power supply ground. Instead the PCB contains footprints for optional installation of 0 ohm resistors at multiple locations to connect these points to power supply ground.

The nominal input voltage is +12V DC. Typical operating power consumption details at different configurations is provided in the Table below.

Vin (V)	Configuration	Current (A)	Power (W)
12V	No Ports Connected	0.55A	6.6W
	Single port connected	0.6A	7.2W
	12 Ports Connected from Module's 8522 PHY	0.87A	10.44W

3.2.4 Serial interface

The VSC7444 switch offers a serial port function controlled by the management software using GPIO lines. These lines are connected to a transceiver to provide an RS-232 connection for alternate connection to the management features of the switch. Only TX and RX signals are provided. The serial interface is provided on a 3-pin latching connector (J6) on EPS-12000-CM carrier board.

3.2.5 Thermal Solution

The main board contains all the active, heat-generating components. It comes standard with an aluminum heat sink in the same shape as the board and mounts to the top of the board via the four corner COM express mini board mounting holes. The heat sink contains built in riser blocks that bring the metal close to the surface of all the heat generating components. Thermal pads fill in the gap between the metal and the component top surfaces. The heat sink is in the outline of a module and is approximately 8mm high. The heat sink is anodized for improved emissivity.

4. MECHANICAL DRAWING

4.1 Main Board

Figure 2 and Figure 3 shows Top and Bottom view of mechanical drawing of the Main board.

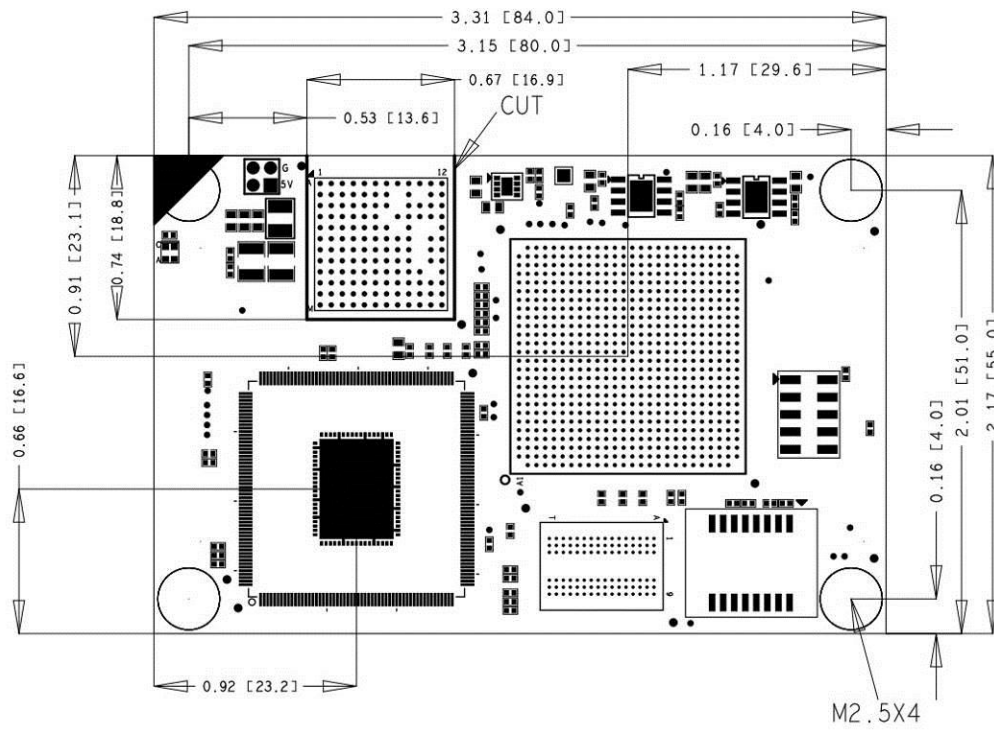

Figure 2 Mechanical Drawing of Main Board (Top View)

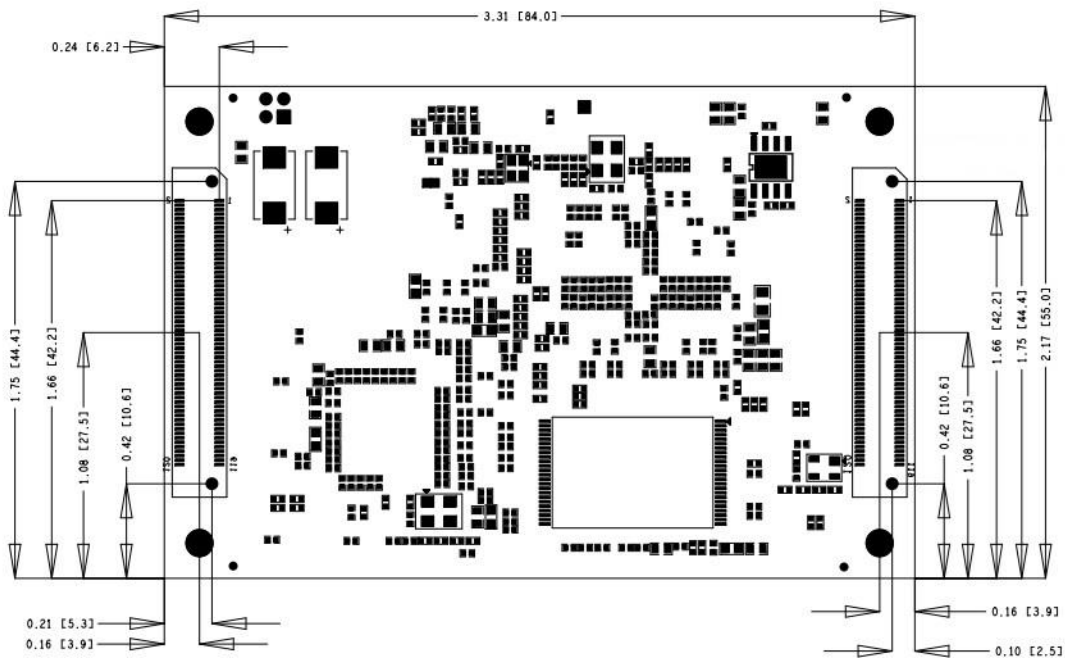

Figure 3 Mechanical Drawing of Main Board (Bottom View)

4.2 EPS-12000-CM CARRIER BOARD

Figure 4 shows the mechanical drawing of the EPS-12000-CM carrier board.

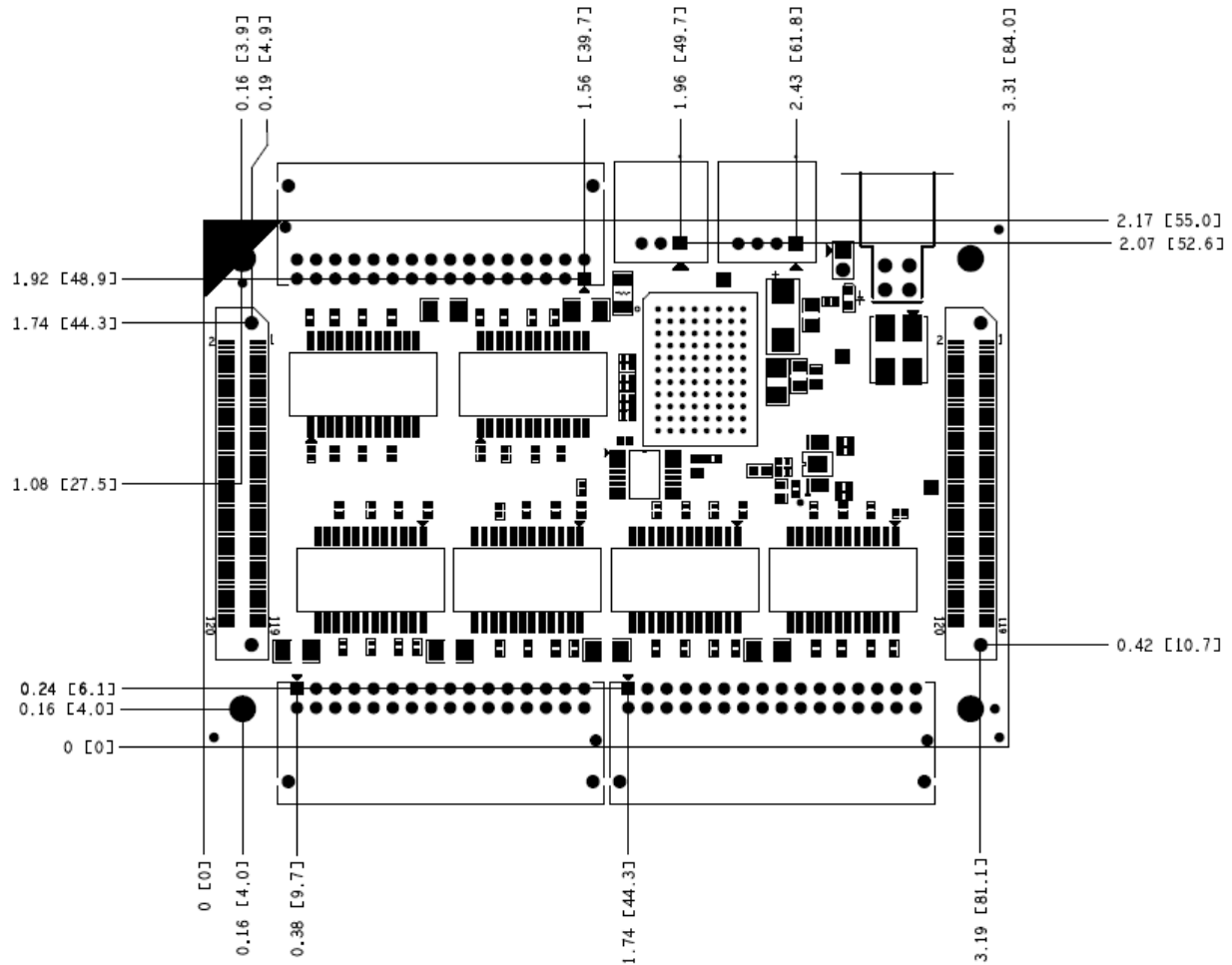

Figure 4 Mechanical Drawing of EPS-12000-CM Carrier Board

4.3 Main Board and EPS-12000-CM Carrier Board

Figure 5 shows the mechanical drawing of the Main board assembled to the carrier board.

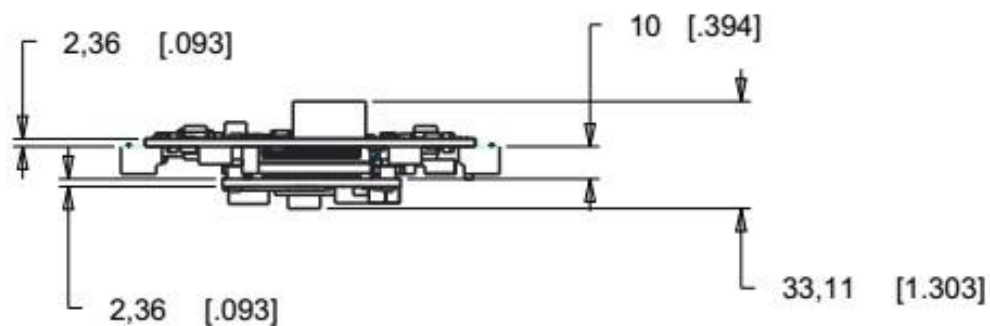

Figure 5 Main Board and EPS-12000-CM Carrier board

5. BOARD LAYOUT

5.1 Main Board

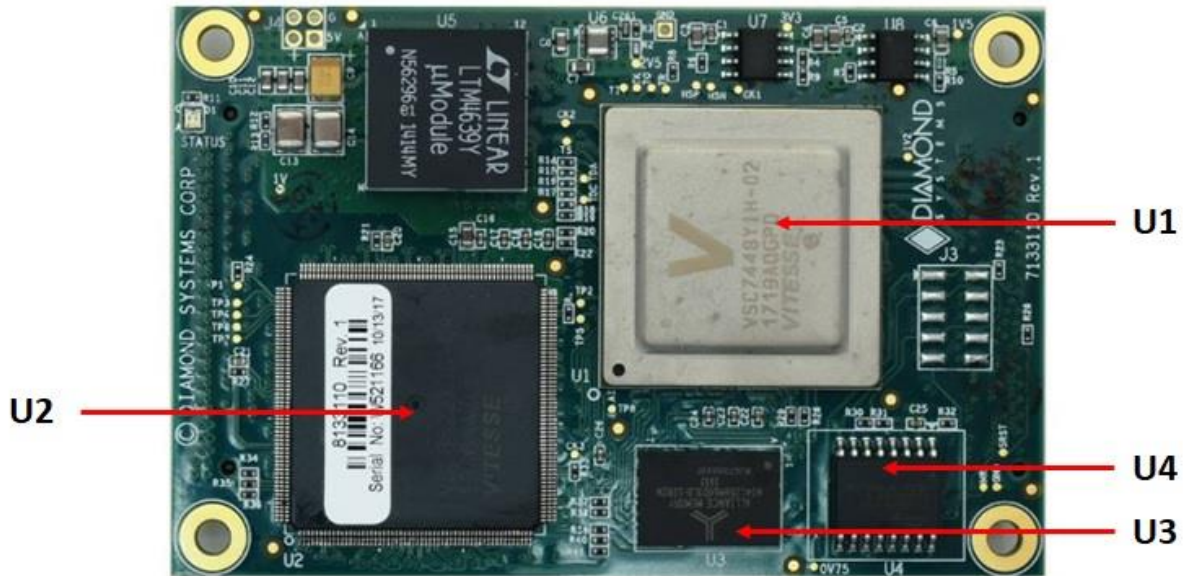

Figure 6 Main Board Layout (TOP View)



Figure 7 Main Board Layout (Bottom View)

5.2 EPS-12000-CM Carrier Board

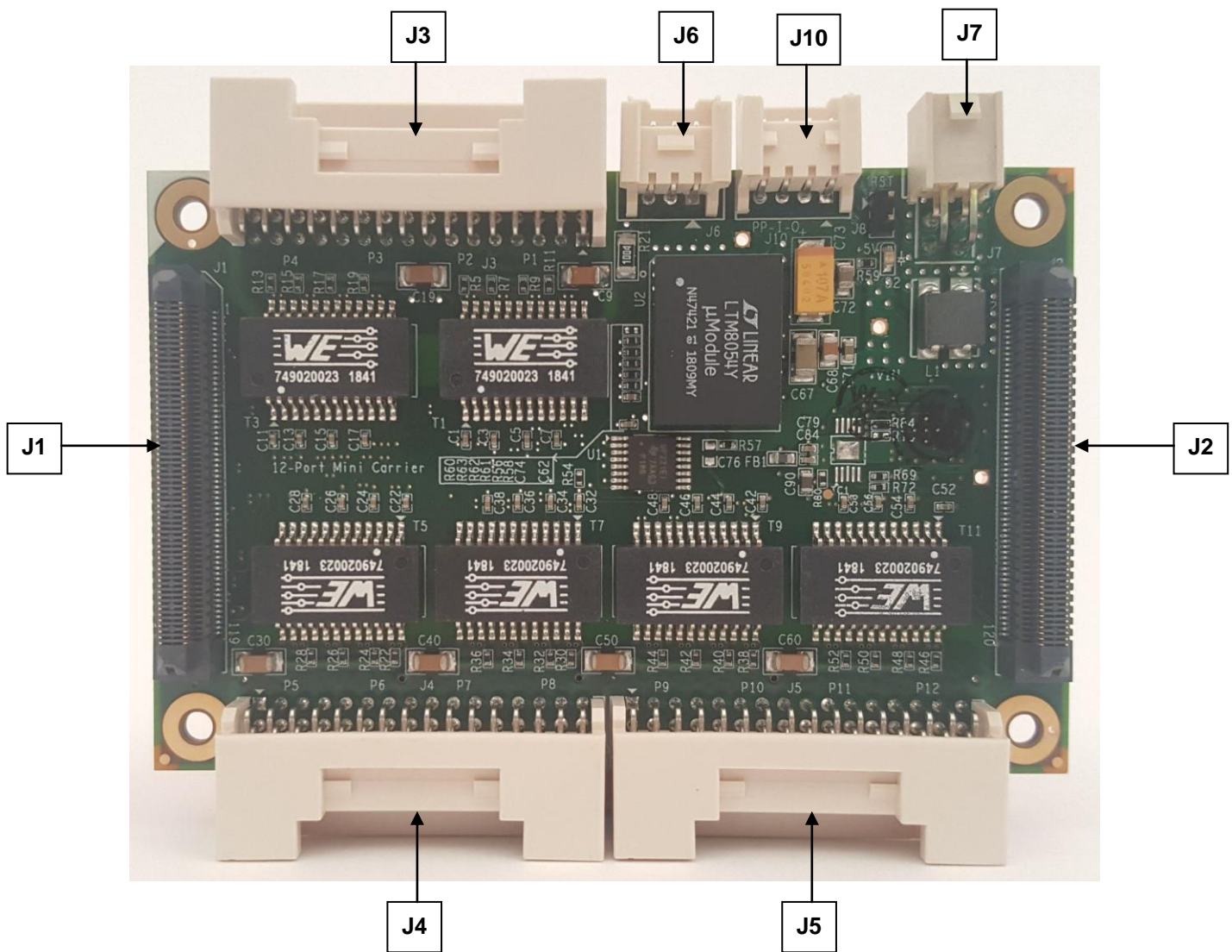

Figure 8 EPS-12000-CM Carrier Board Layout (TOP View)

5.3 Key ICs and Connector List

5.3.1 Main Board

Connector	Function
U1	Vitesse VSC7444 Ethernet switch
U2	Vitesse VSC8522 PHY
U3	DDR3 Memory
U4	SPI Flash
J1, J2	High speed B2B connectors

5.3.2 EPS-12000-CM Carrier Board

Connector	Function
J1, J2	High speed B2B connectors
J3	PORT01 to PORT04
J4	PORT05 to PORT08
J5	PORT09 to PORT12
J6	RS232 Port
J7	Power Input
J10	PPS IO

6. CONNECTOR PINOUT AND DESCRIPTION

6.1 MAIN BOARD

6.1.1 High-speed B2B connectors (J1, J2)

The Main board contains 2x 120 pin 0.5mm pitch High speed connector, which accommodates the 12x 1Gbps copper ports, 3x QSGMII ports, 2x 10G ports, Power and other sideband signals. These connectors mates with the carrier board. Following Table provides the pinout and signal description of connectors J1 and J2 on main board

J1			
Pin Number	Pin Name	Type	Description
1	GND_SIGNAL	Power	Digital Ground
3	SFPPLUSA_RXD_N	I	SFP Port A Receive +
5	SFPPLUSA_RXD_P	I	SFP Port A Receive -
7	GND_SIGNAL	Power	Digital Ground
9	SFPPLUSA_TXD_N	O	SFP Port A Transmit +
11	SFPPLUSA_TXD_P	O	SFP Port A Transmit -
13	GND_SIGNAL	Power	Digital Ground
15	B_PCIE_T_P	O	PCIe Transmit +
17	B_PCIE_T_N	O	PCIe Transmit -
19	GND_SIGNAL	Power	Digital Ground
21	B_PCIE_R_P	I	PCIe Receive +
23	B_PCIE_R_N	I	PCIe Receive -
25	GND_SIGNAL	Power	Digital Ground
27	CLK125_1	O	125MHz clock output-1
29	GND_SIGNAL	Power	Digital Ground
31	CLK125_2	O	125MHz clock output-2
33	GND_SIGNAL	Power	Digital Ground
35	CLK25MHZ3	O	125MHz clock output-3
37	GND_SIGNAL	Power	Digital Ground
39	SFPPLUSA_SCL	O	SFP Port A I2C clock
41	SFPPLUSA_LOS	I	SFP Port A Loss of signal indication
43	SFPPLUSB_SCL	O	SFP Port B I2C clock
45	SFPPLUSB_LOS	I	SFP Port B Loss of signal indication
47	NC	-	No Connect
49	MII2_MDIO	I/O	MDIO for external PHY
51	MII2_MDC	O	Management Data clock output
53	NINT_PHY0	O	Internal PHY interrupt output
55	I2C_SCL	O	General I2C clock output
57	I2C_SDA	I/O	General I2C Data input/output
59	NC	-	No Connect
61	NC	-	No Connect
63	SGPIO2_DO	O	SGPIO Data Out
65	SGPIO2_DI	I	SGPIO Data In
67	COMA_MODE	O	COMA mode output

69	LED_PWM	O	PWM output from on board PHY
71	NC	-	No Connect
73	NC	-	No Connect
75	NC	-	No Connect
77	NC	-	No Connect
79	NINT_PHY1	I	External PHY interrupt
81	NSYSRESET	O	System Reset Output
83	GND_SIGNAL	Power	Digital Ground
85	RTX9DN	I/O	Port 9, Bi-directional pair D-
87	RTX9DP	I/O	Port 9, Bi-directional pair D+
89	GND_SIGNAL	Power	Digital Ground
91	RTX9CN	I/O	Port 9, Bi-directional pair C-
93	RTX9CP	I/O	Port 9, Bi-directional pair C+
95	GND_SIGNAL	Power	Digital Ground
97	RTX10DN	I/O	Port 10, Bi-directional pair D-
99	RTX10DP	I/O	Port 10, Bi-directional pair D+
101	GND_SIGNAL	Power	Digital Ground
103	RTX10CN	I/O	Port 10, Bi-directional pair C-
105	RTX10CP	I/O	Port 10, Bi-directional pair C+
107	GND_SIGNAL	Power	Digital Ground
109	RTX11DN	I/O	Port 11, Bi-directional pair D-
111	RTX11DP	I/O	Port 11, Bi-directional pair D+
113	GND_SIGNAL	Power	Digital Ground
115	RTX11CN	I/O	Port 11, Bi-directional pair C-
117	RTX11CP	I/O	Port 11, Bi-directional pair C+
119	GND_SIGNAL	Power	Digital Ground
2	GND_SIGNAL	Power	Digital Ground
4	SFPPLUSB_RXD_N	I	SFP Port B Receive +
6	SFPPLUSB_RXD_P	I	SFP Port B Receive -
8	GND_SIGNAL	Power	Digital Ground
10	SFPPLUSB_TXD_N	O	SFP Port B Transmit +
12	SFPPLUSB_TXD_P	O	SFP Port B Transmit -
14	GND_SIGNAL	Power	Digital Ground
16	QSGMII_P21_P24_RXD_P	I	Port 21-24, QSGMII Receive +
18	QSGMII_P21_P24_RXD_N	I	Port 21-24, QSGMII Receive -
20	GND_SIGNAL	Power	Digital Ground
22	QSGMII_P21_P24_TXD_P	O	Port 21-24, QSGMII Transmit +
24	QSGMII_P21_P24_TXD_N	O	Port 21-24, QSGMII Transmit -
26	GND_SIGNAL	Power	Digital Ground
28	QSGMII_P17_P20_RXD_P	I	Port 17-20, QSGMII Receive +
30	QSGMII_P17_P20_RXD_N	I	Port 17-20, QSGMII Receive -
32	GND_SIGNAL	Power	Digital Ground
34	QSGMII_P17_P20_TXD_P	O	Port 17-20, QSGMII Transmit +
36	QSGMII_P17_P20_TXD_N	O	Port 17-20, QSGMII Transmit -
38	GND_SIGNAL	Power	Digital Ground
40	QSGMII_P13_P16_RXD_P	I	Port 13-16, QSGMII Receive +
42	QSGMII_P13_P16_RXD_N	I	Port 13-16, QSGMII Receive -

44	GND_SIGNAL	Power	Digital Ground
46	QSGMII_P13_P16_TXD_P	O	Port 13-16, QSGMII Transmit +
48	QSGMII_P13_P16_TXD_N	O	Port 13-16, QSGMII Transmit -
50	GND_SIGNAL	Power	Digital Ground
52	NC	-	No Connect
54	NC	-	No Connect
56	NC	-	No Connect
58	NC	-	No Connect
60	SGPIO2_LD	O	SGPIO Load
62	SGPIO2_CLK	O	SGPIO Clock
64	SLED1_DO	O	SLED1 Data Out
66	SLED1_CLK	O	SLED1 Clock Out
68	SLED0_CLK	O	SLED0 Data Out
70	SLED0_DO	O	SLED0 Clock Out
72	GND_SIGNAL	Power	Digital Ground
74	PCIEWAKE	O	PCIe Wake output
76	GPIO1	I/O	3.3V GPIO-1
78	GPIO2	I/O	3.3V GPIO-2
80	GPIO3	I/O	3.3V GPIO-3
82	GPIO4	I/O	3.3V GPIO-4
84	GND_SIGNAL	Power	Digital Ground
86	RTX9BN	I/O	Port 9, Bi-directional pair B-
88	RTX9BP	I/O	Port 9, Bi-directional pair B+
90	GND_SIGNAL	Power	Digital Ground
92	RTX9AN	I/O	Port 9, Bi-directional pair A-
94	RTX9AP	I/O	Port 9, Bi-directional pair A+
96	GND_SIGNAL	Power	Digital Ground
98	RTX10BN	I/O	Port 10, Bi-directional pair B-
100	RTX10BP	I/O	Port 10, Bi-directional pair B+
102	GND_SIGNAL	Power	Digital Ground
104	RTX10AN	I/O	Port 10, Bi-directional pair A-
106	RTX10AP	I/O	Port 10, Bi-directional pair A+
108	GND_SIGNAL	Power	Digital Ground
110	RTX11BN	I/O	Port 11, Bi-directional pair B-
112	RTX11BP	I/O	Port 11, Bi-directional pair B+
114	GND_SIGNAL	Power	Digital Ground
116	RTX11AN	I/O	Port 11, Bi-directional pair A-
118	RTX11AP	I/O	Port 11, Bi-directional pair A+
120	GND_SIGNAL	Power	Digital Ground

Connector Number: Samtec ERF5-060-05.0-L-DV-K-TR

Mating Connector: Samtec ERM5-060-05.0-L-DV

J2			
Pin Number	Pin Name	Type	Description
1	GND_SIGNAL	Power	Digital Ground
3	RTX0DN	I/O	Port 0, Bi-directional pair D-
5	RTX0DP	I/O	Port 0, Bi-directional pair D+
7	GND_SIGNAL	Power	Digital Ground
9	RTX0CN	I/O	Port 0, Bi-directional pair C-
11	RTX0CP	I/O	Port 0, Bi-directional pair C+
13	GND_SIGNAL	Power	Digital Ground
15	RTX1DN	I/O	Port 1, Bi-directional pair D-
17	RTX1DP	I/O	Port 1, Bi-directional pair D+
19	GND_SIGNAL	Power	Digital Ground
21	RTX1CN	I/O	Port 1, Bi-directional pair C-
23	RTX1CP	I/O	Port 1, Bi-directional pair C+
25	GND_SIGNAL	Power	Digital Ground
27	RTX2DN	I/O	Port 2, Bi-directional pair D-
29	RTX2DP	I/O	Port 2, Bi-directional pair D+
31	GND_SIGNAL	Power	Digital Ground
33	RTX2CN	I/O	Port 2, Bi-directional pair C-
35	RTX2CP	I/O	Port 2, Bi-directional pair C+
37	GND_SIGNAL	Power	Digital Ground
39	RTX3DN	I/O	Port 3, Bi-directional pair D-
41	RTX3DP	I/O	Port 3, Bi-directional pair D+
43	GND_SIGNAL	Power	Digital Ground
45	RTX3CN	I/O	Port 3, Bi-directional pair C-
47	RTX3CP	I/O	Port 3, Bi-directional pair C+
49	GND_SIGNAL	Power	Digital Ground
51	RTX4DN	I/O	Port 4, Bi-directional pair D-
53	RTX4DP	I/O	Port 4, Bi-directional pair D+
55	GND_SIGNAL	Power	Digital Ground
57	RTX4CN	I/O	Port 4, Bi-directional pair C-
59	RTX4CP	I/O	Port 4, Bi-directional pair C+
61	GND_SIGNAL	Power	Digital Ground
63	RTX5DN	I/O	Port 5, Bi-directional pair D-
65	RTX5DP	I/O	Port 5, Bi-directional pair D+
67	GND_SIGNAL	Power	Digital Ground
69	RTX5CN	I/O	Port 5, Bi-directional pair C-
71	RTX5CP	I/O	Port 5, Bi-directional pair C+
73	GND_SIGNAL	Power	Digital Ground
75	RTX6DN	I/O	Port 6, Bi-directional pair D-
77	RTX6DP	I/O	Port 6, Bi-directional pair D+
79	GND_SIGNAL	Power	Digital Ground
81	RTX6CN	I/O	Port 6, Bi-directional pair C-
83	RTX6CP	I/O	Port 6, Bi-directional pair C+
85	GND_SIGNAL	Power	Digital Ground
87	RTX7DN	I/O	Port 7, Bi-directional pair D-

89	RTX7DP	I/O	Port 7, Bi-directional pair D+
91	GND_SIGNAL	Power	Digital Ground
93	RTX7CN	I/O	Port 7, Bi-directional pair C-
95	RTX7CP	I/O	Port 7, Bi-directional pair C+
97	1PPS_0	O	1 PPS clock Output
99	RTX8DN	I/O	Port 8, Bi-directional pair D-
101	RTX8DP	I/O	Port 8, Bi-directional pair D+
103	5V0	Power	+5V Input Supply
105	RTX8CN	I/O	Port 8, Bi-directional pair C-
107	RTX8CP	I/O	Port 8, Bi-directional pair C+
109	RS232_RXD	I	RS232 Receive
111	RS232_TXD	O	RS232 Transmit
113	1PPS_1	I	1 PPS clock Input
115	DB CONFIG1	I	Daughterboard configuration input
117	DB CONFIG2	I	Daughterboard configuration input
119	/MR_RST	I	Manual reset Input (Active Low)
2	GND_SIGNAL	Power	Digital Ground
4	RTX0BN	I/O	Port 0, Bi-directional pair B-
6	RTX0BP	I/O	Port 0, Bi-directional pair B+
8	GND_SIGNAL	Power	Digital Ground
10	RTX0AN	I/O	Port 0, Bi-directional pair A-
12	RTX0AP	I/O	Port 0, Bi-directional pair A+
14	GND_SIGNAL	Power	Digital Ground
16	RTX1BN	I/O	Port 1, Bi-directional pair B-
18	RTX1BP	I/O	Port 1, Bi-directional pair B+
20	GND_SIGNAL	Power	Digital Ground
22	RTX1AN	I/O	Port 1, Bi-directional pair A-
24	RTX1AP	I/O	Port 1, Bi-directional pair A+
26	GND_SIGNAL	Power	Digital Ground
28	RTX2BN	I/O	Port 2, Bi-directional pair B-
30	RTX2BP	I/O	Port 2, Bi-directional pair B+
32	GND_SIGNAL	Power	Digital Ground
34	RTX2AN	I/O	Port 2, Bi-directional pair A-
36	RTX2AP	I/O	Port 2, Bi-directional pair A+
38	GND_SIGNAL	Power	Digital Ground
40	RTX3BN	I/O	Port 3, Bi-directional pair B-
42	RTX3BP	I/O	Port 3, Bi-directional pair B+
44	GND_SIGNAL	Power	Digital Ground
46	RTX3AN	I/O	Port 3, Bi-directional pair A-
48	RTX3AP	I/O	Port 3, Bi-directional pair A+
50	GND_SIGNAL	Power	Digital Ground
52	RTX4BN	I/O	Port 4, Bi-directional pair B-
54	RTX4BP	I/O	Port 4, Bi-directional pair B+
56	GND_SIGNAL	Power	Digital Ground
58	RTX4AN	I/O	Port 4, Bi-directional pair A-
60	RTX4AP	I/O	Port 4, Bi-directional pair A+
62	GND_SIGNAL	Power	Digital Ground

64	RTX5BN	I/O	Port 5, Bi-directional pair B-
66	RTX5BP	I/O	Port 5, Bi-directional pair B+
68	GND_SIGNAL	Power	Digital Ground
70	RTX5AN	I/O	Port 5, Bi-directional pair A-
72	RTX5AP	I/O	Port 5, Bi-directional pair A+
74	GND_SIGNAL	Power	Digital Ground
76	RTX6BN	I/O	Port 6, Bi-directional pair B-
78	RTX6BP	I/O	Port 6, Bi-directional pair B+
80	GND_SIGNAL	Power	Digital Ground
82	RTX6AN	I/O	Port 6, Bi-directional pair A-
84	RTX6AP	I/O	Port 6, Bi-directional pair A+
86	GND_SIGNAL	Power	Digital Ground
88	RTX7BN	I/O	Port 7, Bi-directional pair B-
90	RTX7BP	I/O	Port 7, Bi-directional pair B+
92	GND_SIGNAL	Power	Digital Ground
94	RTX7AN	I/O	Port 7, Bi-directional pair A-
96	RTX7AP	I/O	Port 7, Bi-directional pair A+
98	3V3	Power	+3.3V Input Supply
100	RTX8BN	I/O	Port 8, Bi-directional pair B-
102	RTX8BP	I/O	Port 8, Bi-directional pair B+
104	5V0	Power	+5V Input Supply
106	RTX8AN	I/O	Port 8, Bi-directional pair A-
108	RTX8AP	I/O	Port 8, Bi-directional pair A+
110	5V0	Power	+5V Input Supply
112	5V0	Power	+5V Input Supply
114	5V0	Power	+5V Input Supply
116	5V0	Power	+5V Input Supply
118	5V0	Power	+5V Input Supply
120	5V0	Power	+5V Input Supply

Connector Number: Samtec ERF5-060-05.0-L-DV-K-TR

Mating Connector: Samtec ERM5-060-05.0-L-DV

6.2 EPS-12000-CM Carrier Board

6.2.1 High-speed B2B connectors (J1, J2)

EPS-12000-CM carrier board contains 2x 120 pin 0.5mm pitch High speed connector, which accommodates the 12x 1Gbps copper ports, Power and other sideband signals. These connectors mates with the EPSM-10GX main module.

		J1			
GND_SIGNAL	1		2	GND_SIGNAL	
RTX0DN	3		4	RTX0BN	
RTX0DP	5		6	RTX0BP	
GND_SIGNAL	7		8	GND_SIGNAL	
RTX0CN	9		10	RTX0AN	
RTX0CP	11		12	RTX0AP	
GND_SIGNAL	13		14	GND_SIGNAL	
RTX1DN	15		16	RTX1BN	
RTX1DP	17		18	RTX1BP	
GND_SIGNAL	19		20	GND_SIGNAL	
RTX1CN	21		22	RTX1AN	
RTX1CP	23		24	RTX1AP	
GND_SIGNAL	25		26	GND_SIGNAL	
RTX2DN	27		28	RTX2BN	
RTX2DP	29		30	RTX2BP	
GND_SIGNAL	31		32	GND_SIGNAL	
RTX2CN	33		34	RTX2AN	
RTX2CP	35		36	RTX2AP	
GND_SIGNAL	37		38	GND_SIGNAL	
RTX3DN	39		40	RTX3BN	
RTX3DP	41		42	RTX3BP	
GND_SIGNAL	43		44	GND_SIGNAL	
RTX3CN	45		46	RTX3AN	
RTX3CP	47		48	RTX3AP	
GND_SIGNAL	49		50	GND_SIGNAL	
RTX4DN	51		52	RTX4BN	
RTX4DP	53		54	RTX4BP	
GND_SIGNAL	55		56	GND_SIGNAL	
RTX4CN	57		58	RTX4AN	
RTX4CP	59		60	RTX4AP	
GND_SIGNAL	61		62	GND_SIGNAL	
RTX5DN	63		64	RTX5BN	
RTX5DP	65		66	RTX5BP	
GND_SIGNAL	67		68	GND_SIGNAL	
RTX5CN	69		70	RTX5AN	
RTX5CP	71		72	RTX5AP	
GND_SIGNAL	73		74	GND_SIGNAL	
RTX6DN	75		76	RTX6BN	

RTX6DP	77	78	RTX6BP
GND_SIGNAL	79	80	GND_SIGNAL
RTX6CN	81	82	RTX6AN
RTX6CP	83	84	RTX6AP
GND_SIGNAL	85	86	GND_SIGNAL
RTX7DN	87	88	RTX7BN
RTX7DP	89	90	RTX7BP
GND_SIGNAL	91	92	GND_SIGNAL
RTX7CN	93	94	RTX7AN
RTX7CP	95	96	RTX7AP
PPS-0	97	98	NC
RTX8DN	99	100	RTX8BN
RTX8DP	101	102	RTX8BP
5V0	103	104	5V0
RTX8CN	105	106	RTX8AN
RTX8CP	107	108	RTX8AP
UART_RXD	109	110	5V0
UART_TXD	111	112	5V0
PPS-1	113	114	5V0
DB CONFIG1	115	116	5V0
DB CONFIG2	117	118	5V0
/MR_RST	119	120	5V0

Connector Number: Samtec ERM5-060-05.0-L-DV

Mating Connector: Samtec ERF5-060-05.0-L-DV-K-TR

J2			
GND_SIGNAL	1	2	GND_SIGNAL
SFPPLUSA_RXD_N	3	4	SFPPLUSB_RXD_N
SFPPLUSA_RXD_P	5	6	SFPPLUSB_RXD_P
GND_SIGNAL	7	8	GND_SIGNAL
SFPPLUSA_TXD_N	9	10	SFPPLUSB_TXD_N
SFPPLUSA_TXD_P	11	12	SFPPLUSB_TXD_P
GND_SIGNAL	13	14	GND_SIGNAL
B_PCIE_T_P	15	16	QSGMII_P21_P24_RXD_P
B_PCIE_T_N	17	18	QSGMII_P21_P24_RXD_N
GND_SIGNAL	19	20	GND_SIGNAL
B_PCIE_R_P	21	22	QSGMII_P21_P24_TXD_P
B_PCIE_R_N	23	24	QSGMII_P21_P24_TXD_N
GND_SIGNAL	25	26	GND_SIGNAL
CLK125_1	27	28	QSGMII_P17_P20_RXD_P
GND_SIGNAL	29	30	QSGMII_P17_P20_RXD_N
CLK125_2	31	32	GND_SIGNAL
GND_SIGNAL	33	34	QSGMII_P17_P20_TXD_P
CLK25MHZ3	35	36	QSGMII_P17_P20_TXD_N

GND_SIGNAL	37	38	GND_SIGNAL
SFPPLUSA_SCL	39	40	QSGMII_P13_P16_RXD_P
SFPPLUSA_LOS	41	42	QSGMII_P13_P16_RXD_N
SFPPLUSB_SCL	43	44	GND_SIGNAL
SFPPLUSB_LOS	45	46	QSGMII_P13_P16_TXD_P
NC	47	48	QSGMII_P13_P16_TXD_N
MII2_MDIO	49	50	GND_SIGNAL
MII2_MDC	51	52	NC
NINT_PHY0	53	54	NC
I2C_SCL	55	56	NC
I2C_SDA	57	58	NC
NC	59	60	SGPIO2_LD
NC	61	62	SGPIO2_CLK
SGPIO2_DO	63	64	SLED1_DO
SGPIO2_DI	65	66	SLED1_CLK
COMA_MODE	67	68	SLED0_CLK
LED_PWM	69	70	SLED0_DO
NC	71	72	GND_SIGNAL
NC	73	74	PCIEWAKE
NC	75	76	GPIO1
NC	77	78	GPIO2
NINT_PHY1	79	80	GPIO3
NSYSRESET	81	82	GPIO4
GND_SIGNAL	83	84	GND_SIGNAL
RTX9DN	85	86	RTX9BN
RTX9DP	87	88	RTX9BP
GND_SIGNAL	89	90	GND_SIGNAL
RTX9CN	91	92	RTX9AN
RTX9CP	93	94	RTX9AP
GND_SIGNAL	95	96	GND_SIGNAL
RTX10DN	97	98	RTX10BN
RTX10DP	99	100	RTX10BP
GND_SIGNAL	101	102	GND_SIGNAL
RTX10CN	103	104	RTX10AN
RTX10CP	105	106	RTX10AP
GND_SIGNAL	107	108	GND_SIGNAL
RTX11DN	109	110	RTX11BN
RTX11DP	111	112	RTX11BP
GND_SIGNAL	113	114	GND_SIGNAL
RTX11CN	115	116	RTX11AN
RTX11CP	117	118	RTX11AP
GND_SIGNAL	119	120	GND_SIGNAL

Connector Number: Samtec ERM5-060-05.0-L-DV

Mating Connector: Samtec ERF5-060-05.0-L-DV-K-TR

6.2.2 Ethernet Ports (J3, J4, J5)

The EPS-12000-CM carrier board contains three identical connectors with four Ethernet ports per connector. Each port has four pairs of differential signals. The Ethernet connections are connected to the board's power supply ground via a 1000pF/2KV capacitor and 100K ohm (2KV rated) resistor.

J3, J4 and J5 are the three connectors available on EPS-12000-CM carrier board for the Ethernet ports.

DD+	1	2	DD-	Port 1
DC+	3	4	DC-	
DB+	5	6	DB-	
DA+	7	8	DA-	
DD+	9	10	DD-	Port 2
DC+	11	12	DC-	
DB+	13	14	DB-	
DA+	15	16	DA-	
DD+	17	18	DD-	Port 3
DC+	19	20	DC-	
DB+	21	22	DB-	
DA+	23	24	DA-	
DD+	25	26	DD-	Port 4
DC+	27	28	DC-	
DB+	29	30	DB-	
DA+	31	32	DA-	

Connector Number: JST S32B-PUDSS-1

Mating Connector: Housing: PUDP-32V-S Crimp terminal: SPUD-002T-P0.5

6.2.3 Serial Interface (J6)

EPS-12000-CM carrier board contains a RS-232 connector which connects the on-board microcontroller to an external serial port.

J6	
1	RX
2	TX
3	GND

Connector Number: Molex 35363-0360

Mating Connector: Housing: 0355070300 Crimp terminal: 0502128100

6.2.4 Power Input (J7)

EPS-12000-CM carrier board operates from a wide range power supply of +7V to +34VDC. Power is provided through a 4-pin latching connector. Below is the pin-out for input power.

Vin 7-34VDC	1	2	Ground
Vin 7-34VDC	3	4	Ground

Connector Number: Samtec IPL1-102-01-L-D-RA-K-ND

Mating Connector: Housing: IPD1-02-D-K Crimp terminal: CC79R-2024-01-F

6.2.5 PPS Interface (J6)

EPS-12000-CM carrier board contains a PPS connector which provides PPS input and out put. This feature is available only with the iStax version of firmware.

J6

1	PPS out
2	GND
3	PPS in
4	GND

Connector Number: Molex 35363-0460

Mating Connector: Housing: 0355070400 Crimp terminal: 0502128100

7. ASSEMBLING/DISASSEMBLING THE CARRIER BOARDS

The EPS-12000-CM carrier board and EPSM-10GX main module should be assembled or disassembled with the utmost care. The board can be damaged if significant pressure is applied while doing so.

The photos in this section show how to assemble the main board on to the carrier board when the heatsink has been installed on the main board.

Figure 9 shows the top view of the main board after the heat sink is installed.



Figure 9 EPSM-10GX with Heatsink

Figure 10 shows the bottom view of the main board, highlighting connector J1 and J2 where the carrier board is installed.



Figure 10 Bottom view of the Main Board

Figure 11 shows the TOP view of the EPS-12000-CM carrier board and identifies connector J1 and J2, which is installed in connector J2 and J1 of the main board respectively.



Figure 11 Top view of the carrier board

Figure 12 shows the front view of the complete setup of Main board connected to EPS-12000-CM carrier board

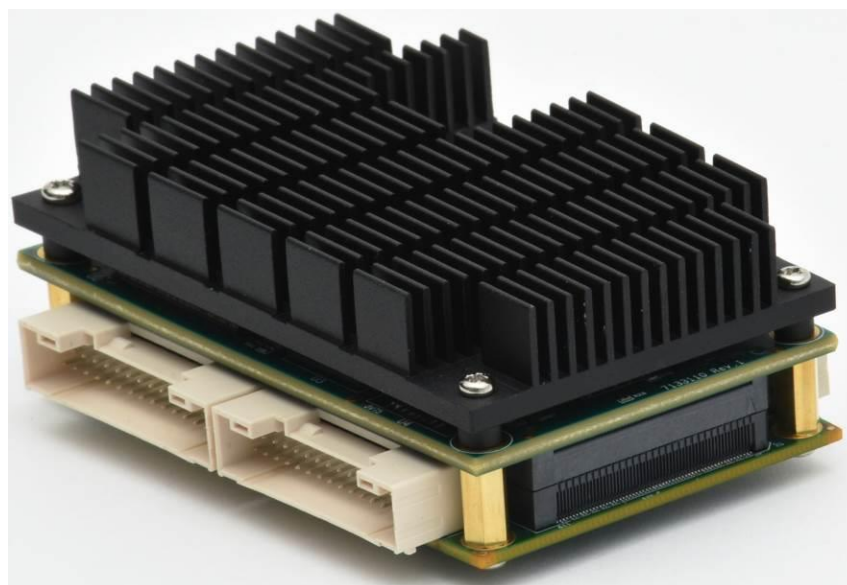

Figure 12 Complete Setup

8. GETTING STARTED

This section provides the steps necessary to set up the EPS-10GX with EPS-12000-CM carrier board.

1. Connect the serial cable, part number **6981050**, between the connector **J6** on the carrier board and a PC's serial port. Open the HyperTerminal application with baud rate set to 115200bps.
2. Connect the Ethernet cables, part number **6981508**, from PC's Ethernet port/ Ethernet Switch, to any of the connectors **J3, J4 or J5** on carrier board, depending on the number of active ports used.
3. Connect a LAN cable between the PC to any one of the desired ports on the cable(s) connected to the EPS-12000-CM switch in step 2.
4. EPS-12000-CM carrier board works on a wide range of voltages from +7V to +34V. Connect the power cable, part number **6981507**, between the connector **J7** and a regulated power supply.
5. Switch on the power supply and view the messages on the hyper terminal. The default user id is **admin** with no password.
6. Set the default gateway as 192.168.1.60 to access the Web interface.

WEB INTERFACE AND CLI OVERVIEW

The command line interface (CLI) is a model, line-based interface with no screen editing features where commands are executed immediately upon end-of-line. The CLI can be accessed directly via the RS-232 serial connection. The user must log in before CLI commands can be executed

The web interface offers an alternate user interface to the CLI. The web interface is in-band and requires use of one of the Ethernet ports. This port provides simultaneous web management and normal usage. The same commands with the same functionality can be accessed via either interface.

9. USING THE CLI INTERFACE

9.1 Making an Initial Connection

Serial line configuration:

- 115200 baud
- 8-bit data
- No parity
- 1 stop bit

Login information

```
Username: admin
Password: {none}
```

The board is shipped with an IP address of 192.168.1.60. This allows the WEB interface to be accessed at that address.

The IP address, mask and gateway must be set according to the environment, or can enable IP and DHCP if the environment includes a DHCP server. For example:

```
# configure terminal
(config)# interface vlan 1
(config-if-vlan)# ip address dhcp
(config-if-vlan)# end
```

Below example depicts configuration of static IP address,

```
# configure terminal
(config)# interface vlan 1
(config-if-vlan)# ip address 192.168.1.60 255.255.0.0
(config-if-vlan)# end
```

Display the IP address to confirm:

```
# show ip interface brief
Vlan Address          Method  Status
-----
  1 192.168.1.60      Manual  UP
#
```

9.2 Login/Logout Procedures

To get access to the CLI, the user must login by entering a username and password. The user will automatically be queried about the password. The password is configurable. Log out at any time and at any context level using the exit command.

9.3 Help Utility

Help is provided when the `?` key or entering `help` is pressed. The help information depends on the context:

- At top level, a list of command groups is displayed.
- At group level, a list of the command syntaxes for the current group is displayed.
- If the help command is issued for a specific command, the command syntax and a description of the command are shown.

9.4 Entering Commands

- Commands are not case-sensitive.
- Use the horizontal arrow keys, `←` and `→`, to move the cursor within the command being entered.
- Use the backspace key (provided the user is using a terminal that sends the BS (8) character when the backspace key is pressed) to delete characters from the command being entered.
- Use the vertical arrow-keys, `↑` and `↓`, to scroll through a command history buffer of the latest twenty commands issued.

9.5 General Command Groups

The following groups of general commands are available in the command line interface (CLI).

```
# ?
clear          Reset functions
configure     Enter configuration mode
copy          Copy from source to destination
debug         Debugging functions
delete        Delete one file in flash: file system
dir           Directory of all files in flash: file system
disable       Turn off privileged commands
do            To run exec commands in config mode
dot1x         IEEE Standard for port-based Network Access Control
enable        Turn on privileged commands
exit          Exit from EXEC mode
firmware      Firmware upgrade/swap
help          Description of the interactive help system
ip            IPv4 commands
logout        Exit from EXEC mode
more          Display file
no            Negate a command or set its defaults
ping          Send ICMP echo messages
reload        Reload system.
send          Send a message to other tty lines
show          Show running system information
terminal      Set terminal line parameters
#
```

9.5.1 IP Commands

1. The following commands should be used to enable the secure HTTP web redirect and secure HTTP web server. Secure web redirection cannot be enabled until the secure web server is enabled.
 - (config)# ip http secure-redirect
 - (config)# ip http secure-server
2. View status of both HTTP web server and web redirection.
 - # show ip http server secure status
3. To disable the secure HTTP web redirect and secure HTTP web server.
 - (config)# no ip http secure-redirect
 - (config)# no ip http secure-server
4. To enable the Global IGMP snooping. Unregistered IPMCv4 traffic flooding can also be enabled.
 - (config)# ip igmp snooping
 - (config)# ip igmp snooping vlan <v_vlan_list>
 - (config)# ip igmp unknown-flooding
5. To view the IGMP snooping and to view the IGMP router port status.
 - # show ip igmp snooping [vlan <v_vlan_list>] [group-database [interface (<port_type> [<v_port_type_list>])] [sfm-information]] [detail]
 - # show ip igmp snooping mrouter [detail]
6. To disable the IGMP snooping and flooding.
 - (config)# no ip igmp snooping
 - (config)# no ip igmp snooping vlan [<v_vlan_list>]
 - (config)# no ip igmp unknown-flooding
7. To configure the IP route, to view the IP interface, route and statistics, to clear the IP route, IGMP snooping and IP statistics.
 - (config)# ip route <v_ipv4_addr> <v_ipv4_netmask> <v_ipv4_gw>
 - (config)# no ip route <v_ipv4_addr> <v_ipv4_netmask> <v_ipv4_gw>
 - # show ip arp
 - # show ip interface brief
 - # show ip route
 - # show ip statistics [system] [interface vlan <v_vlan_list>] [icmp] [icmp-msg <type>]
 - # clear ip arp
 - # clear ip igmp snooping [vlan <v_vlan_list>] statistics
 - # clear ip statistics [system] [interface vlan <v_vlan_list>] [icmp] [icmp-msg <type>]

9.5.2 MAC Commands

The MAC address table can be configured using the following commands. By default, dynamic entries are removed from the MAC table after 300 seconds. However, the aging time of the dynamic MAC table can be configured using the commands as well.

- (config)# mac address-table aging-time <v_0_10_to_1000000>
- (config)# no mac address-table aging-time
- (config)# no mac address-table aging-time <v_0_10_to_1000000>

The static MAC address-table can be configured, viewed and cleared using the following commands.

- (config)# mac address-table static <v_mac_addr> vlan <v_vlan_id> interface (<port_type> [<v_port_type_list>])
- (config)# no mac address-table static <v_mac_addr> vlan <v_vlan_id> interface (<port_type> [<v_port_type_list>])
- # clear mac address-table
- # show mac address-table [conf | static | aging-time | { { learning | count } [interface (<port_type> [<v_port_type_list>])] } | { address <v_mac_addr> [vlan <v_vlan_id>] } | vlan <v_vlan_id_1> [interface (<port_type> [<v_port_type_list_1>])]]

9.5.3 VLAN/PVLAN Commands

The following commands can be used to configure the VLAN of Access Ports which is the Access VLANs. Ports in other modes are members of all VLANs specified in the Allowed VLANs field.

Private VLANs can be added or deleted here. Port members of each Private VLAN can be added or removed here. Private VLANs are based on the source port mask, and there are no connections to VLANs. This means that VLAN IDs and Private VLAN IDs can be identical. A port must be a member of both a VLAN and a Private VLAN to be able to forward packets. By default, all ports are VLAN unaware and members of VLAN 1 and Private VLAN. A VLAN unaware port can only be a member of one VLAN, but it can be a member of multiple Private VLANs.

- (config)# interface vlan <vlist>
- (config)# vlan <vlist>
- (config)# vlan ethertype s-custom-port <etype>
- (config)# no interface vlan <vlist>
- (config)# no vlan { { ethertype s-custom-port } | <vlan_list> }
- # show interface vlan [<vlist>]
- # show pvlan [<pvlan_list>]
- # show pvlan isolation [interface (<port_type> [<plist>])]
- # show vlan [id <vlan_list> | name <name> | brief]
- # show vlan status [interface (<port_type> [<plist>])] [combined | admin | nas | mvr | voice-vlan | mstp | erps | vcl | evc | gvrp | all | conflicts]

9.5.4 dot1x (IEEE Standard for port-based Network Access Control)

The IEEE 802.1X standard defines a port-based access control procedure that prevents unauthorized access to a network by requiring users to first submit credentials for authentication. One or more central servers, the back-end servers, determine whether the user is allowed access to the network.

The network access control commands allow the user to enable or disable the NAS on the switch. If disabled all ports are allowed forwarding of frames.

The commands can also be used to configure the time interval to check for the activity on the successfully authenticated MAC address, to configure the re-authentication interval for 802.1X-enabled ports to detect if a

new device is plugged into a switch port or if a supplicant is no longer attached. The re-authentication period would determine an interval after which a connected client must be re-authenticated.

- (config)# dot1x system-auth-control
- (config)# dot1x re-authentication
- (config)# dot1x authentication timer inactivity <v_10_to_100000>
- (config)# dot1x authentication timer re-authenticate <v_1_to_3600>
- (config)# dot1x timeout quiet-period <v_10_to_1000000>
- (config)# dot1x timeout tx-period <v_1_to_65535>
- (config)# no dot1x authentication timer inactivity
- (config)# no dot1x authentication timer re-authenticate
- (config)# no dot1x re-authentication
- (config)# no dot1x system-auth-control
- (config)# no dot1x timeout quiet-period
- (config)# no dot1x timeout tx-period
- # clear dot1x statistics [interface (<port_type> [<v_port_type_list>])]
- # dot1x initialize [interface (<port_type> [<plist>])]
- # show dot1x statistics { eapol | radius | all } [interface (<port_type> [<v_port_type_list>])]
- # show dot1x status [interface (<port_type> [<v_port_type_list>])] [brief]

9.5.5 LACP Commands

LACP commands can be used to configure the aggregation ID, Partner's ID, Partner's Key and Priority of the partner's port. The status of the ID's and the connectivity to the partner port can be viewed and cleared as well.

- (config)# lacp system-priority <v_1_to_65535>
- (config)# no lacp system-priority <v_1_to_65535>
- # clear lacp statistics
- # show lacp { internal | statistics | system-id | neighbour }

9.5.6 LLDP Commands

The following commands can be used to configure the LLDP hold-time, to configure the time taken to reinitialize LLDP after a shutdown, to configure the interval between each LLDP frame, to configure the transmission delay to transmit the new LLDP frame due to some configuration changes.

- (config)# lldp holdtime <val>
- (config)# lldp reinit <val>
- (config)# lldp timer <val>
- (config)# lldp transmission-delay <val>

Similarly, hold-time, reinit time, timer and the transmission delay can be disabled using the following commands.

- (config)# no lldp holdtime
- (config)# no lldp reinit
- (config)# no lldp timer
- (config)# no lldp transmission-delay

The following commands can be used to view LLDP neighbors, to view or clear the LLDP statistics.

- # clear lldp statistics
- # show lldp eee [interface (<port_type> [<v_port_type_list>])]
- # show lldp neighbors [interface (<port_type> [<v_port_type_list>])]
- # show lldp statistics [interface (<port_type> [<v_port_type_list>])]

9.5.7 Access Management Commands

The switch will be allowed to access only if the application's type matches any one of the access management. Below are the commands to configure the access management table, where access ID, access VLAN ID, start IP address, End IP address can be set. The command can also be used to define the interface (WEB, SNMP or TELNET) from which the host can access the switch. For this to happen, the host IP address should match the IP address provided in the command.

- (config)# access management <access_id> <access_vid> <start_addr> [to <end_addr>] { [web] [snmp] [telnet] | all }
- (config)# no access management
- (config)# no access management <access_id_list>
- # clear access management statistics
- # show access management [statistics | <access_id_list>]

9.5.8 Access-list Commands

The following commands can be used to set the Access list ace ID, to set the rate limiter in pps or kbps, to disable the access list, to clear the access list statistics, and to view the access list ace status and statistics.

- (config)# access-list ace <Aceld : 1-256>
- (config)# access-list rate-limiter [<rate_limiter_list>] { pps <pps_rate> | 100pps <pps100_rate> | kpps <kpps_rate> | 100kbps <kpbs100_rate> }
- (config)# default access-list rate-limiter [<rate_limiter_list>]
- (config)# no access-list ace <ace_list>
- # clear access-list ace statistics
- # show access-list [interface [(<port_type> [<v_port_type_list>])]] [rate-limiter [<rate_limiter_list>]] [ace statistics [<ace_list>]]
- # show access-list ace-status [static] [link-oam] [loop-protect] [dhcp] [ptp] [upnp] [arp-inspection] [evc] [mep] [ipmc] [ip-source-guard] [ip-mgmt] [conflicts] [switch <switch_list>]

9.5.9 Logging Commands

The following commands can be used to enable or disable the server mode operations, and to determine the kind of messages which can be sent to the syslog sever which is possible when the logging level is set.

- (config)# logging host <v_word45>
- (config)# logging level { info | warning | error }
- (config)# logging on
- (config)# no logging host
- (config)# no logging on
- # clear logging [info] [warning] [error] [switch <switch_list>]
- # show logging <log_id> [switch <switch_list>]
- # show logging [info] [warning] [error] [switch <switch_list>]

9.5.10 Spanning-Tree Commands

Spanning-tree commands can be used to enable or disable the spanning-tree mode enabling the user to select the protocol (STP, RSTP, MSTP), to control whether a port explicitly configured as EDGE will transmit and receive BPDUs or will disable itself upon reception of BPDU (port will enter the error-disabled state, and will be removed from the active topology), to set the interval before a port in the error-disabled state can be enabled, to set the number of BPDU's a bridge port can send per second (when exceeded, transmission of the next BPDU will be delayed).

- (config)# spanning-tree aggregation
- (config)# spanning-tree mode { stp | rstp | mstp }
- (config)# spanning-tree edge bpdu-filter
- (config)# spanning-tree edge bpdu-guard
- (config)# spanning-tree recovery interval <interval>
- (config)# spanning-tree transmit hold-count <holdcount>

To disable the Spanning-tree configurations, clear its statistics and view the spanning-tree summary.

- (config)# no spanning-tree edge bpdu-filter
- (config)# no spanning-tree edge bpdu-guard
- (config)# no spanning-tree mode
- (config)# no spanning-tree recovery interval
- (config)# no spanning-tree transmit hold-count
- # clear spanning-tree { { statistics [interface (<port_type> [<v_port_type_list>])] } | { detected-protocols [interface (<port_type> [<v_port_type_list_1>])] } }
- # show spanning-tree [summary | active | { interface (<port_type> [<v_port_type_list>]) } | { detailed [interface (<port_type> [<v_port_type_list_1>])] } | { mst [configuration | { <instance> [interface (<port_type> [<v_port_type_list_2>])] }] } }

9.5.11 Green-Ethernet Commands

Green Ethernet commands are used to configure the LEDs and to optimize their power consumption. EEE is a power saving option that reduces the power usage when there is low or no traffic utilization. EEE works by powering down circuits when there is no traffic. When a port gets data to be transmitted all circuits are powered up. The time it takes to power up the circuits is named wake-up time. The default wake-up time is 17us for 1Gbit links and 30us for other link speeds. EEE devices must agree upon the value of the wake-up time in order to make sure that both the receiving and transmitting device has all circuits powered up when traffic is transmitted. When a port is powered down for saving power, outgoing traffic is stored in a buffer until the port is powered up again.

These commands help the switch optimize EEE for either best power saving or least traffic latency, to set the interval at which the LED's intensity shall be set to the corresponding intensity, to set the interval for which the LED is ON corresponding to the particular intensity. If no intensity is specified for the next hour, the intensity is set to the default intensity.

- (config)# green-ethernet eee optimize-for-power
- (config)# green-ethernet led interval <v_0_to_24> intensity <v_0_to_100>
- (config)# green-ethernet led on-event { [link-change <v_0_to_65535>] [error] } *1

The following commands can be used to disable the EEE optimizations for the LEDs and also to view the status of the Green-Ethernet LEDs.

- (config)# no green-ethernet eee optimize-for-power
- (config)# no green-ethernet led interval <0~24>
- (config)# no green-ethernet led on-event [link-change] [error]
- # show green-ethernet [interface (<port_type> [<port_list>])]
- # show green-ethernet eee [interface (<port_type> [<port_list>])]
- # show green-ethernet energy-detect [interface (<port_type> [<port_list>])]
- # show green-ethernet short-reach [interface (<port_type> [<port_list>])]

9.5.12 Thermal-protect Commands

These commands are used to configure the current settings for controlling the thermal protection. When the temperature exceeds the configured thermal protection temperature, ports will be turned off in order to decrease the power consumption. It is possible to arrange the ports with different priorities. Each priority can be given a temperature at which the corresponding ports shall be turned off.

- (config)# no thermal-protect prio <prio_list>
- (config)# thermal-protect prio <prio_list> temperature <new_temp>
- # show thermal-protect [interface (<port_type> [<port_list>])]
- Loop-protect Commands

To inspect the current Loop Protection configurations, and possibly change them as well, to set the interval between each loop protection PDU sent on each port, to set the period for which a port will be kept disabled in the event of a loop is detected (and the port action shuts down the port).

- (config)# loop-protect
- (config)# loop-protect shutdown-time <t>
- (config)# loop-protect transmit-time <t>

To disable the loop protection for the ports and to view the loop-protect interface and its status.

- (config)# no loop-protect
- (config)# no loop-protect shutdown-time
- (config)# no loop-protect transmit-time
- # show loop-protect [interface (<port_type> [<plist>])]

9.5.13 QoS Commands

To set how the bandwidth of the received frames are limited (unicast, multicast or broadcast) accordingly the rate should also be set, to set the QCE ID which determines the QoS class, the following commands can be used.

- (config)# qos storm { unicast | multicast | broadcast } { { <rate> [kfps] } { 1024 kfps } }
- (config)# no qos qce <qce_id_range>
- (config)# no qos storm { unicast | multicast | broadcast }
- # show qos [{ interface [(<port_type> [<port>])] } | wred | { maps [dscp-cos] [dscp-ingress-translation] [dscp-classify] [cos-dscp] [dscp-egress-translation] } | storm | { qce [<qce>] }]

9.5.14 Privilege Commands

These commands are limited to the OS running in the board.

- (config)# privilege { exec | configure | config-vlan | line | interface | if-vlan | ipmc-profile | snmps-host | stp-aggr | dhcp-pool | rfc2544-profile } level <privilege> <cmd>
- (config)# no privilege { exec | configure | config-vlan | line | interface | if-vlan | ipmc-profile | snmps-host | stp-aggr | dhcp-pool | rfc2544-profile } level <0-15> <cmd>
- # show privilege

9.5.15 SNMP Commands

To enable the SNMP, set the version, set the group name and security mode, and to enable or disable the Trap mode. The read and write access strings to permit access to the SNMP agent can also be set for SNMPv1 or SNMPv2c versions. As for SNMPv3 the community string will be associated with SNMPv3 communities table.

For SNMPv3 user configuration the command will include the user-name, engine ID, authentication protocol and password, privacy protocol and password. Please note that change of the engine ID will clear all original local users.

- (config)# snmp-server
- (config)# snmp-server version { v1 | v2c | v3 }
- (config)# snmp-server security-to-group model { v1 | v2c | v3 } name <security_name> group <group_name>
- (config)# snmp-server access <group_name> model { v1 | v2c | v3 | any } level { auth | noauth | priv } [read <view_name>] [write <write_name>]
- (config)# snmp-server community v2c <comm> [ro | rw]
- (config)# snmp-server community v3 <v3_comm> [<v_ipv4_addr> <v_ipv4_netmask>]
- (config)# snmp-server contact <v_line255>
- (config)# snmp-server engine-id local <engineID>
- (config)# snmp-server host <conf_name>
- (config)# snmp-server location <v_line255>
- (config)# snmp-server trap
- (config)# snmp-server user <username> engine-id <engineID> [{ md5 <md5_passwd> | sha <sha_passwd> } [priv { des | aes } <priv_passwd>]]
- (config)# snmp-server view <view_name> <oid_subtree> { include | exclude }

To view or disable the set SNMP server settings:

- (config)# no snmp-server
- (config)# no snmp-server version
- (config)# no snmp-server security-to-group model { v1 | v2c | v3 } name <security_name>
- (config)# no snmp-server access <group_name> model { v1 | v2c | v3 | any } level { auth | noauth | priv }
- (config)# no snmp-server community v2c
- (config)# no snmp-server community v3 <community>
- (config)# no snmp-server contact
- (config)# no snmp-server engine-id local
- (config)# no snmp-server host <conf_name>
- (config)# no snmp-server location
- (config)# no snmp-server trap
- (config)# no snmp-server user <username> engine-id <engineID>
- (config)# no snmp-server view <view_name> <oid_subtree>
- # show snmp
- # show snmp access [<group_name> { v1 | v2c | v3 | any } { auth | noauth | priv }]
- # show snmp community v3 [<community>]

- # show snmp host [<conf_name>] [system] [switch] [interface] [aaa]
- # show snmp mib context
- # show snmp mib ifmib ifIndex
- # show snmp security-to-group [{ v1 | v2c | v3 } <security_name>]
- # show snmp user [<username> <engineID>]
- # show snmp view [<view_name> <oid_subtree>]

9.5.16 SNMP Commands

These commands are used to enable or disable the SNMP client mode operation and to set the IPv4 or IPv6 address of a SNMP server.

- (config)# snmp
- (config)# snmp server ip-address { <ipv4_var> }
- (config)# no snmp
- (config)# no snmp server
- # show snmp status

9.5.17 Radius Server Commands

These commands are used to configure the NAS-IP-Address (Attribute 4) and NAS-Identifier (Attribute 32). The IPv4 address is used as attribute 4 in RADIUS Access-Request packets. The identifier-up to 253 characters long is used as attribute 32 in RADIUS Access-Request packets.

Using the below commands a Global Secret Key, which is shared between the RADIUS server and the switch, can be set. Other features that can be set are the Global Timeout to wait for a reply from the RADIUS server before re-transmitting the request, a Global Retransmit number for which RADIUS request is sent to a server which is not responding, and the Dead Time interval for which no new RADIUS requests are sent to a sever which has failed to respond to the previous requests. Setting the Dead time will stop the switch from continually trying to contact a server that it has already determined as dead.

- (config)# radius-server attribute 32 <id>
- (config)# radius-server attribute 4 <ipv4>
- (config)# radius-server key <key>
- (config)# radius-server retransmit <retries>
- (config)# radius-server timeout <seconds>
- (config)# radius-server deadtime <minutes>

The following command is used to set the IP address of the RADIUS server, to set the UDP port to use on the RADIUS server for authentication and accounting, and to set an optional timeout, optional retransmit and optional key which overrides the global time out, global retransmit number and global key following commands can be used.

- (config)# radius-server host <host_name> [auth-port <auth_port>] [acct-port <acct_port>] [timeout <seconds>] [retransmit <retries>] [key <key>]

The following commands can be used to view the RADIUS server running status and its statistics, and to disable all the RADIUS server settings.

- (config)# no radius-server attribute 32
- (config)# no radius-server attribute 4
- (config)# no radius-server deadtime
- (config)# no radius-server host <host_name> [auth-port <auth_port>] [acct-port <acct_port>]
- (config)# no radius-server key
- (config)# no radius-server retransmit
- (config)# no radius-server timeout

- # show radius-server [statistics]
- # show running-config [all-defaults]
- # show running-config feature <feature_name> [all-defaults]
- # show running-config interface (<port_type> [<list>]) [all-defaults]
- # show running-config interface vlan <list> [all-defaults]
- # show running-config line { console | vty } <list> [all-defaults]
- # show running-config vlan <list> [all-defaults]

9.5.18 Banner Commands

A banner can be defined before and after log in using these commands.

- (config)# banner [motd] <banner>
- (config)# banner exec <banner>
- (config)# banner login <banner>
- (config)# no banner [motd]
- (config)# no banner exec
- (config)# no banner login

9.5.19 Terminal Commands

These commands are generic terminal commands used to change the settings of the terminal.

- (config)# no terminal editing
- (config)# no terminal exec-timeout
- (config)# no terminal history size
- (config)# no terminal length
- (config)# no terminal width
- # terminal editing
- # terminal exec-timeout <min> [<sec>]
- # terminal help
- # terminal history size <history_size>
- # terminal length <lines>
- # terminal width <width>

9.5.20 Reload

```
reload { { cold | warm } [ sid <usid> ] } | { defaults [ keep-ip ] }
```

9.5.21 Firmware Commands

These commands can be used to upgrade the firmware through a given FTP server path and to swap the between the actual and the backup firmware images.

- # firmware swap
- # firmware upgrade <tftpserver_path_file>

9.5.22 Ping Commands

Use this command to ping the device.

- # ping ip <v_ip_addr> [repeat <count>] [size <size>] [interval <seconds>]

9.5.23 Debug Commands

Use these commands to debug the board.

- (config)# no debug prompt
- (config)# line { <0~16> | console 0 | vty <0~15> }
- # no debug prompt
- # debug prompt <debug_prompt>

9.5.24 Security Commands

These commands can be used to set the password in encrypted form or unencrypted form or can be set to NONE, to enable or disable the AAA authentication login (console, telnet, ssh or http) and to enable or disable the execution level of the password.

- (config)# password encrypted <enry_password>
- (config)# password none
- (config)# password unencrypted <password>
- (config)# aaa authentication login { console | telnet | ssh | http } { { local | radius | tacacs } [{ local | radius | tacacs }] [{ local | radius | tacacs }] }
- (config)# enable password [level <priv>] <password>
- (config)# enable secret { 0 | 5 } [level <priv>] <password>
- (config)# no aaa authentication login { console | telnet | ssh | http }
- (config)# no enable password [level <priv>]
- (config)# no enable secret { [0 | 5] } [level <priv>]
- # show aaa
- # show port-security port [interface (<port_type> [<v_port_type_list>])]
- # show port-security switch [interface (<port_type> [<v_port_type_list>])]

9.5.25 Monitor

- (config)# monitor destination interface <port_type> <in_port_type>
- (config)# monitor source { { interface (<port_type> [<v_port_type_list>]) } | { cpu [<cpu_switch_range>] } } { both | rx | tx }
- (config)# no monitor destination
- (config)# no monitor source { { interface (<port_type> [<v_port_type_list>]) } | { cpu [<cpu_switch_range>] } }

9.5.26 POE

Power management mode and the Reserved Power of Power over Ethernet can be set using these commands. To determine the amount of power a port may use, you should define the amount of power a power source can deliver, which can also be set ranging from 0 to 2000 watts.

- (config)# poe management mode { class-consumption | class-reserved-power | allocation-consumption | allocation-reserved-power | lldp-consumption | lldp-reserved-power }
- (config)# poe supply sid <v_1_to_24> <v_1_to_2000>
- (config)# no poe management mode
- (config)# no poe supply [sid <v_1_to_12>]
- # show poe [interface (<port_type> [<v_port_type_list>])]

9.5.27 Examples

9.5.28 IP Configuration

Below example depicts configuration of static IP address,

```
# configure terminal
(config)# interface vlan 1
(config-if-vlan)# ip address 192.168.1.60 255.255.0.0
(config-if-vlan)# end
```

Display the IP address to confirm:

```
# show ip interface brief
Vlan Address                Method  Status
-----
  1 192.168.1.60            Manual  UP
#
```

9.5.29 Port Configuration

Individual ports can be configured to different speeds. The following example shows configuring speed as 100 Mbps for port 1.

```
# configure terminal
(config)# interface GigabitEthernet 1/1
(config-if)# speed ?
  10          10Mbps
  100         100Mbps
  1000        1Gbps
  auto        Auto negotiation
(config-if)# speed 100
(config-if)# end
#
```

9.5.30 Change Switch Password

The following example shows setting of a new password,

```
# configure terminal
(config)# password unencrypted <password>
(config)# exit
#
```

9.5.31 Set up VLANs

Virtual LANs (VLANs) are used to divide the network into separate logical areas. VLANs can also be considered as broadcast domains.

The following example shows setting up VLAN2 and VLAN3 with switch port mode set to access.

```
#configure terminal
(config)# vlan 2
(config)# vlan 3
```

Set access port, in this case it's assumed that port 1~3 are connected to PC. The PVID of each port is different.

```
#configure terminal
(config)# interface GigabitEthernet 1/2
(Config-if)# switchport mode access
```

```
(Config-if)# switchport access vlan 2
(config)# exit
(config)# interface GigabitEthernet 1/3
(Config-if)# switchport mode access
(Config-if)# switchport access vlan 3
(config)# exit
```

To verify a created VLAN

```
# show vlan
VLAN  Name                               Interfaces
----  -
1      default                                Gi 1/1,4-8
2      VLAN0002                               Gi 1/2
3      VLAN0003                               Gi 1/3
```

As shown above, VLAN2 is created with the name VLAN0002 and a port 2 assigned to VLAN2. Similarly port 3 assigned to VLAN0003. Remaining ports 1 & 4 to 8 are by default assigned to VLAN 1

9.5.32 SNMP configuration

The following example depicts the configuration of SNMP.

To enable the SNMP mode operation

```
# configure terminal
(config)# snmp-server
(config)# exit
#
```

SNMP Trap configuration

```
# configure terminal
(config)# snmp-server host Example
(config-snmp-host)# host 192.168.1.20
(config-snmp-host)# exit
(config)# exit
#
```

9.5.33 Mirroring

For debugging network problems or monitoring network traffic, the switch system can be configured to mirror frame from multiple ports to a mirror port. The following example depicts the mirroring of Port 2, Port 3 (RX), and Port 4 traffic to 8 (Rx) to Port 1.

```
# configure terminal
(config)# monitor destination interface GigabitEthernet 1/1
(config)# monitor source interface GigabitEthernet 1/2-3 rx
(config)# monitor source interface GigabitEthernet 1/4-8 tx
```

9.5.34 Setup QoS

Quality of Service (QoS) refers to the capability of a network to provide better service to selected network traffic over various technologies, including Frame Relay, Asynchronous Transfer Mode (ATM), Ethernet and 802.1 networks, SONET, and IP-routed networks that may use any or all of these underlying technologies.

The following example shows setting up the QoS. All traffic coming on Port 1 is mapped to QoS class (CoS) 2 and PCP is set as 1.

```
# configure terminal
(config)# interface GigabitEthernet 1/1
(config-if)# qos cos 2
(config-if)# qos pcp 1
(config-if)# end
```

9.5.35 Firmware Upgrade

A new WebStax image can be downloaded using the CLI. Copy the EPSM-10GX.dat file to a TFTP server and use the firmware upgrade command to download the file.

```
# firmware upgrade tftp://<ip_address>/<path>/EPSM-10GX.dat
#
```

9.5.36 Factory defaults

User can reset the configuration of the switch by below command. Only the IP configuration is retained.

```
# reload defaults
#
```

Note: To load the factory default configuration including the IP address, follow steps explained in section 10.6.1

9.5.1 Board Version Commands

User can verify board type by below command.

```
# show board
#
```

10. USING THE WEB INTERFACE

Using the web interface following functionalities can be performed:

- Set port mode
- Enable/disable flow control
- Configure simple port-based VLAN
- Configure aggregation groups
- Configure LACP parameters
- Configure QoS
- Configure SNMP
- Mirroring
- Read and clear statistics counters
- Monitor LACP status
- Configure and monitor 802.1X
- Configure and monitor IGMP snooping (if defined for switch device)
- Configure source-IP address and DHCP server filter
- Upgrade software

The GUI screens will change depending upon the number of ports connected. For EPS-12000-CM board, which has 12 ports, the GUI will be as shown below in Figure 13.

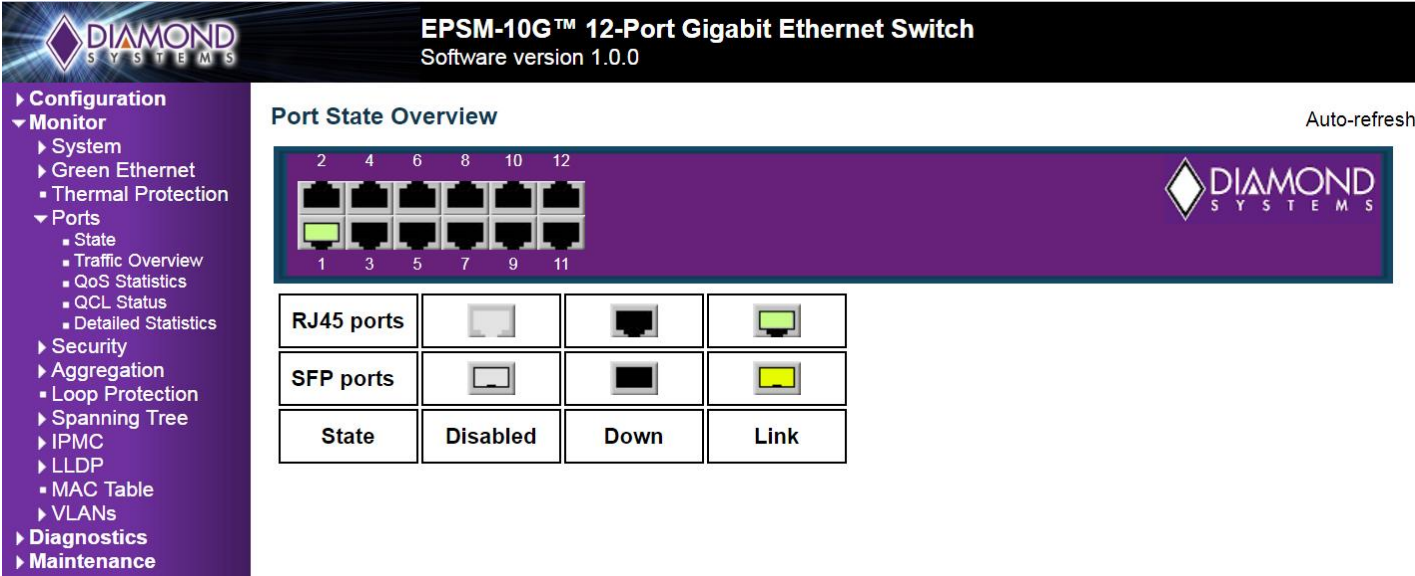







State	Disabled	Down	Link
RJ45 ports			
SFP ports			

Figure 13 Home page of EPS-12000-CM carrier board.

10.1 Examples

10.1.1 IP configuration

The IP address of the switch can be configured as follows:

1. Connect to the web interface of EPS-12000-CM switch
2. Navigate to Configuration -> System -> IP
3. Modify the IP Address in IPv4 Address column
4. Click on Save.
5. Navigate to Maintenance -> Configuration -> Save Startup-Config and click on Save Configuration

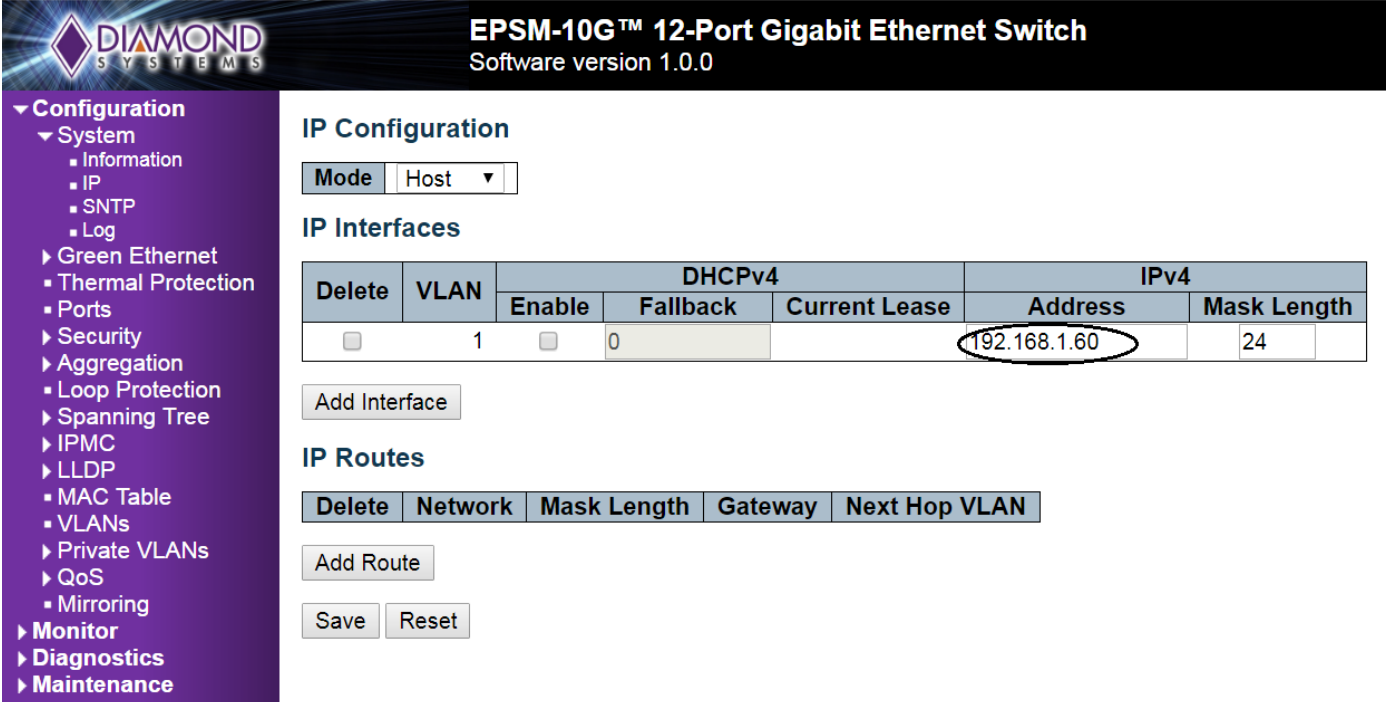

EPMS-10G™ 12-Port Gigabit Ethernet Switch
Software version 1.0.0

IP Configuration
Mode: Host

IP Interfaces

Delete	VLAN	DHCPv4			IPv4	
		Enable	Fallback	Current Lease	Address	Mask Length
<input type="checkbox"/>	1	<input type="checkbox"/>	0		192.168.1.60	24

Add Interface

IP Routes

Delete	Network	Mask Length	Gateway	Next Hop VLAN
--------	---------	-------------	---------	---------------

Add Route

Save Reset

Figure 14 IP Configuration

10.1.2 Port Configuration

Individual ports can be configured as follows:

1. Connect to the web interface of EPS-12000-CM switch
2. Navigate to Configuration -> Ports
3. Each port can be set for one of the following configurations,
 - a. Disabled – Disables the switch port operation
 - b. Auto – Port auto negotiating speed with the link partner and selects the highest speed that is compatible with the link partner
 - c. 10 Mbps HDX – Forces the cu port in 10Mbps half-duplex mode
 - d. 10 Mbps FDX – Forces the cu port in 10Mbps full-duplex mode
 - e. 100 Mbps HDX – Forces the cu port in 100Mbps half-duplex mode
 - f. 100 Mbps FDX – Forces the cu port in 100Mbps full duplex mode
 - g. 1 Gbps FDX – Forces the port in 1Gbps full duplex
4. After port configuration is done click on save
5. To save these settings permanently navigate to Maintenance -> Configuration -> Save Startup-config click on Save startup configuration

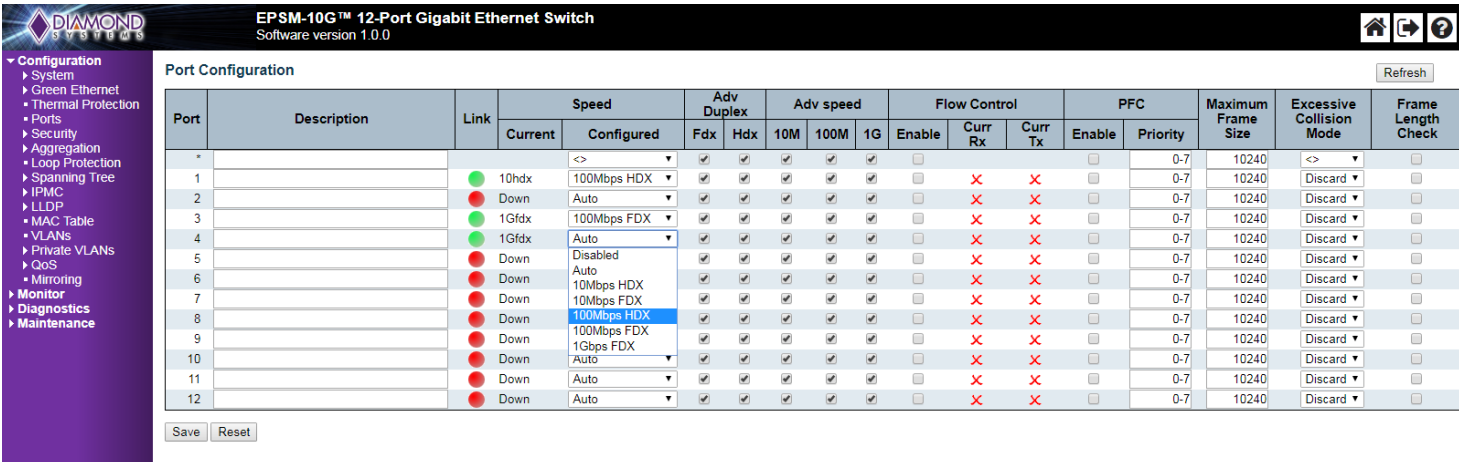

Port	Description	Link	Speed		Adv Duplex		Adv speed			Flow Control			PFC		Maximum Frame Size	Excessive Collision Mode	Frame Length Check	
			Current	Configured	Fdx	Hdx	10M	100M	1G	Enable	Curr Rx	Curr Tx	Enable	Priority				
*				<>														
1		10hdx	10hdx	100Mbps HDX	<input checked="" type="checkbox"/>	<input checked="" type="checkbox"/>	<input checked="" type="checkbox"/>	<input checked="" type="checkbox"/>	<input checked="" type="checkbox"/>	<input checked="" type="checkbox"/>	<input type="checkbox"/>	<input type="checkbox"/>	<input type="checkbox"/>	<input type="checkbox"/>	0-7	10240	<>	<input type="checkbox"/>
2		Down	Down	Auto	<input checked="" type="checkbox"/>	<input checked="" type="checkbox"/>	<input checked="" type="checkbox"/>	<input checked="" type="checkbox"/>	<input checked="" type="checkbox"/>	<input checked="" type="checkbox"/>	<input type="checkbox"/>	<input type="checkbox"/>	<input type="checkbox"/>	<input type="checkbox"/>	0-7	10240	Discard	<input type="checkbox"/>
3		1Gfdx	1Gfdx	100Mbps FDX	<input checked="" type="checkbox"/>	<input checked="" type="checkbox"/>	<input checked="" type="checkbox"/>	<input checked="" type="checkbox"/>	<input checked="" type="checkbox"/>	<input checked="" type="checkbox"/>	<input type="checkbox"/>	<input type="checkbox"/>	<input type="checkbox"/>	<input type="checkbox"/>	0-7	10240	Discard	<input type="checkbox"/>
4		1Gfdx	1Gfdx	Auto	<input checked="" type="checkbox"/>	<input checked="" type="checkbox"/>	<input checked="" type="checkbox"/>	<input checked="" type="checkbox"/>	<input checked="" type="checkbox"/>	<input checked="" type="checkbox"/>	<input type="checkbox"/>	<input type="checkbox"/>	<input type="checkbox"/>	<input type="checkbox"/>	0-7	10240	Discard	<input type="checkbox"/>
5		Down	Down	Disabled	<input checked="" type="checkbox"/>	<input checked="" type="checkbox"/>	<input checked="" type="checkbox"/>	<input checked="" type="checkbox"/>	<input checked="" type="checkbox"/>	<input checked="" type="checkbox"/>	<input type="checkbox"/>	<input type="checkbox"/>	<input type="checkbox"/>	<input type="checkbox"/>	0-7	10240	Discard	<input type="checkbox"/>
6		Down	Down	Auto	<input checked="" type="checkbox"/>	<input checked="" type="checkbox"/>	<input checked="" type="checkbox"/>	<input checked="" type="checkbox"/>	<input checked="" type="checkbox"/>	<input checked="" type="checkbox"/>	<input type="checkbox"/>	<input type="checkbox"/>	<input type="checkbox"/>	<input type="checkbox"/>	0-7	10240	Discard	<input type="checkbox"/>
7		Down	Down	10Mbps HDX	<input checked="" type="checkbox"/>	<input checked="" type="checkbox"/>	<input checked="" type="checkbox"/>	<input checked="" type="checkbox"/>	<input checked="" type="checkbox"/>	<input checked="" type="checkbox"/>	<input type="checkbox"/>	<input type="checkbox"/>	<input type="checkbox"/>	<input type="checkbox"/>	0-7	10240	Discard	<input type="checkbox"/>
8		Down	Down	10Mbps FDX	<input checked="" type="checkbox"/>	<input checked="" type="checkbox"/>	<input checked="" type="checkbox"/>	<input checked="" type="checkbox"/>	<input checked="" type="checkbox"/>	<input checked="" type="checkbox"/>	<input type="checkbox"/>	<input type="checkbox"/>	<input type="checkbox"/>	<input type="checkbox"/>	0-7	10240	Discard	<input type="checkbox"/>
9		Down	Down	100Mbps HDX	<input checked="" type="checkbox"/>	<input checked="" type="checkbox"/>	<input checked="" type="checkbox"/>	<input checked="" type="checkbox"/>	<input checked="" type="checkbox"/>	<input checked="" type="checkbox"/>	<input type="checkbox"/>	<input type="checkbox"/>	<input type="checkbox"/>	<input type="checkbox"/>	0-7	10240	Discard	<input type="checkbox"/>
10		Down	Down	100Mbps FDX	<input checked="" type="checkbox"/>	<input checked="" type="checkbox"/>	<input checked="" type="checkbox"/>	<input checked="" type="checkbox"/>	<input checked="" type="checkbox"/>	<input checked="" type="checkbox"/>	<input type="checkbox"/>	<input type="checkbox"/>	<input type="checkbox"/>	<input type="checkbox"/>	0-7	10240	Discard	<input type="checkbox"/>
11		Down	Down	1Gbps FDX	<input checked="" type="checkbox"/>	<input checked="" type="checkbox"/>	<input checked="" type="checkbox"/>	<input checked="" type="checkbox"/>	<input checked="" type="checkbox"/>	<input checked="" type="checkbox"/>	<input type="checkbox"/>	<input type="checkbox"/>	<input type="checkbox"/>	<input type="checkbox"/>	0-7	10240	Discard	<input type="checkbox"/>
12		Down	Down	Auto	<input checked="" type="checkbox"/>	<input checked="" type="checkbox"/>	<input checked="" type="checkbox"/>	<input checked="" type="checkbox"/>	<input checked="" type="checkbox"/>	<input checked="" type="checkbox"/>	<input type="checkbox"/>	<input type="checkbox"/>	<input type="checkbox"/>	<input type="checkbox"/>	0-7	10240	Discard	<input type="checkbox"/>

Figure 15 Port configuration

10.1.3 Change Switch Password

The switch login password can be changed as follows:

1. Connect to the web interface of EPS-12000-CM switch
2. Navigate to Configuration -> Security ->Switch -> Password
3. Enter the Old password and New Password and click on Save
4. Navigate to Maintenance -> Configuration -> Save Startup-Config and click on Save Configuration

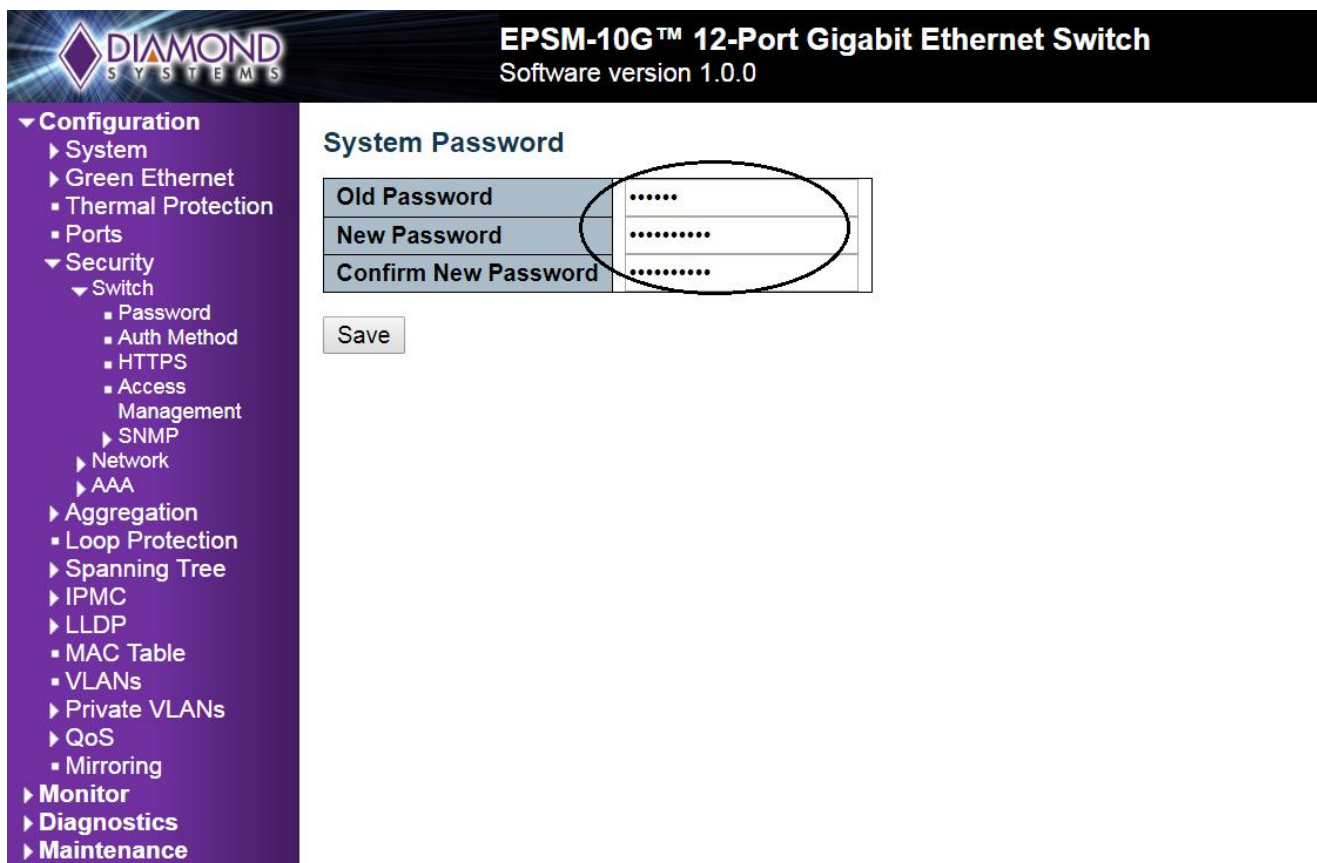
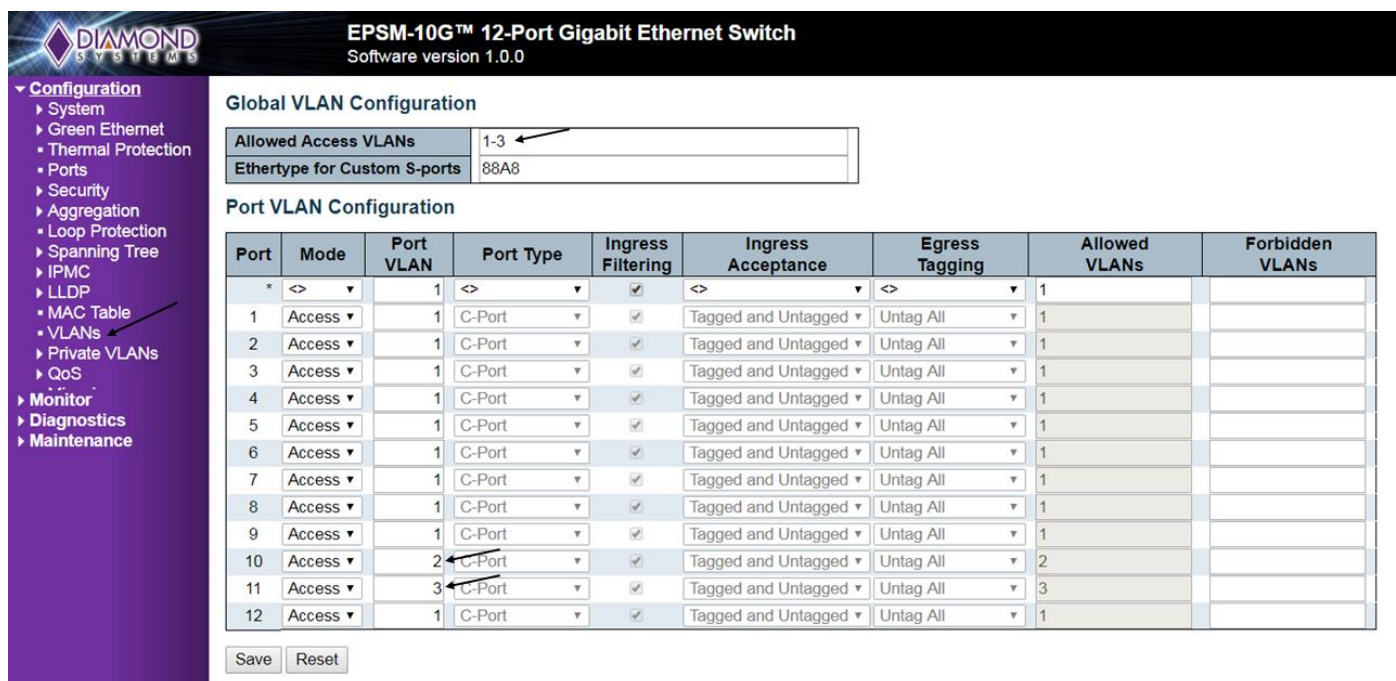

Figure 16 Changing Password

10.1.4 Set up VLANs

The following example shows how to configure a VLAN:

1. Connect to the web interface of EPS-12000-CM switch
2. Navigate to Configuration -> VLANS
 1. In the allowed access VLANs enter number of LANs to be created. In this example 1-3, that creates VLAN2 and VLAN3
 2. By default mode is access, it can be changed to trunk or hybrid by changing Mode drop down list
 3. Assign a ports to the virtual LANs by changing the values in the Port VLAN column
 4. Click on Save to save the VLAN configuration
 5. To save VLAN settings permanently navigate to Maintenance -> Configuration -> Save startup-config click on save startup configuration



Global VLAN Configuration

Allowed Access VLANs	1-3
Ethertype for Custom S-ports	88A8

Port VLAN Configuration

Port	Mode	Port VLAN	Port Type	Ingress Filtering	Ingress Acceptance	Egress Tagging	Allowed VLANs	Forbidden VLANs
*	<>	1	<>	<input checked="" type="checkbox"/>	<>	<>	1	
1	Access	1	C-Port	<input checked="" type="checkbox"/>	Tagged and Untagged	Untag All	1	
2	Access	1	C-Port	<input checked="" type="checkbox"/>	Tagged and Untagged	Untag All	1	
3	Access	1	C-Port	<input checked="" type="checkbox"/>	Tagged and Untagged	Untag All	1	
4	Access	1	C-Port	<input checked="" type="checkbox"/>	Tagged and Untagged	Untag All	1	
5	Access	1	C-Port	<input checked="" type="checkbox"/>	Tagged and Untagged	Untag All	1	
6	Access	1	C-Port	<input checked="" type="checkbox"/>	Tagged and Untagged	Untag All	1	
7	Access	1	C-Port	<input checked="" type="checkbox"/>	Tagged and Untagged	Untag All	1	
8	Access	1	C-Port	<input checked="" type="checkbox"/>	Tagged and Untagged	Untag All	1	
9	Access	1	C-Port	<input checked="" type="checkbox"/>	Tagged and Untagged	Untag All	1	
10	Access	2	C-Port	<input checked="" type="checkbox"/>	Tagged and Untagged	Untag All	2	
11	Access	3	C-Port	<input checked="" type="checkbox"/>	Tagged and Untagged	Untag All	3	
12	Access	1	C-Port	<input checked="" type="checkbox"/>	Tagged and Untagged	Untag All	1	

Save Reset

Figure 17 VLAN Setup

After saving the VLAN configuration, VLAN membership status can be verified as follows,

1. Navigate to Monitor -> VLANs -> Membership
2. Ports 1 to 9 and port 12 are assigned to VLAN ID 1, Port 10 is assigned to VLAN ID 2 and Port 11 is assigned to VLAN ID 3

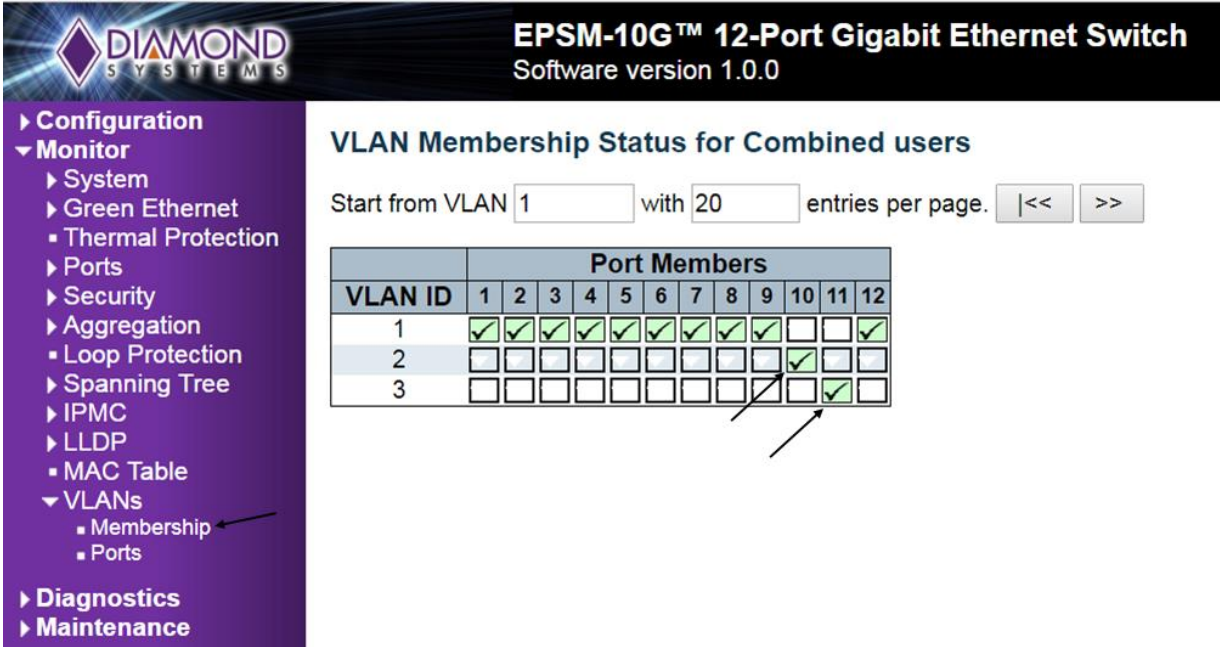

DIAMOND SYSTEMS **EPSM-10G™ 12-Port Gigabit Ethernet Switch**
Software version 1.0.0

▶ Configuration
 ▼ Monitor
 ▶ System
 ▶ Green Ethernet
 ▪ Thermal Protection
 ▶ Ports
 ▶ Security
 ▶ Aggregation
 ▪ Loop Protection
 ▶ Spanning Tree
 ▶ IPMC
 ▶ LLDP
 ▪ MAC Table
 ▼ VLANs
 ▪ Membership ←
 ▪ Ports
 ▶ Diagnostics
 ▶ Maintenance

VLAN Membership Status for Combined users

Start from VLAN with entries per page. |<< >>

VLAN ID	Port Members											
	1	2	3	4	5	6	7	8	9	10	11	12
1	<input checked="" type="checkbox"/>	<input checked="" type="checkbox"/>	<input checked="" type="checkbox"/>	<input checked="" type="checkbox"/>	<input checked="" type="checkbox"/>	<input checked="" type="checkbox"/>	<input checked="" type="checkbox"/>	<input checked="" type="checkbox"/>	<input checked="" type="checkbox"/>	<input type="checkbox"/>	<input type="checkbox"/>	<input checked="" type="checkbox"/>
2	<input type="checkbox"/>	<input type="checkbox"/>	<input type="checkbox"/>	<input type="checkbox"/>	<input type="checkbox"/>	<input type="checkbox"/>	<input type="checkbox"/>	<input type="checkbox"/>	<input type="checkbox"/>	<input checked="" type="checkbox"/>	<input type="checkbox"/>	<input type="checkbox"/>
3	<input type="checkbox"/>	<input type="checkbox"/>	<input type="checkbox"/>	<input type="checkbox"/>	<input type="checkbox"/>	<input type="checkbox"/>	<input type="checkbox"/>	<input type="checkbox"/>	<input type="checkbox"/>	<input type="checkbox"/>	<input checked="" type="checkbox"/>	<input type="checkbox"/>

Figure 18 VLAN Membership

10.1.5 SNMP configuration

The following procedure describes the SNMP configuration:

1. Connect to the web interface of EPS-12000-CM switch
2. Navigate to Configuration -> Security -> Switch -> SNMP -> System, and Enable the Mode and set the SNMP version (example: SNMP v1, SNMP v2c & SNMP v3)

Note: - *SNMP Trap configuration feature is not available currently unable to enter SNMP trap destination port address using Web UI. Please refer [SNMP configuration](#) section to configure this.*

10.1.6 Mirroring

For debugging network problems or monitoring network traffic, the switch system can be configured to mirror frames from multiple ports to a mirror port. The following example shows how to mirror the traffic of Port 1 (Tx) & 2(Rx) to Port 6.

1. Connect to the web interface of EPS-12000-CM switch
2. Navigate to Configuration -> Mirroring
3. Click on Save to save the mirroring configuration.

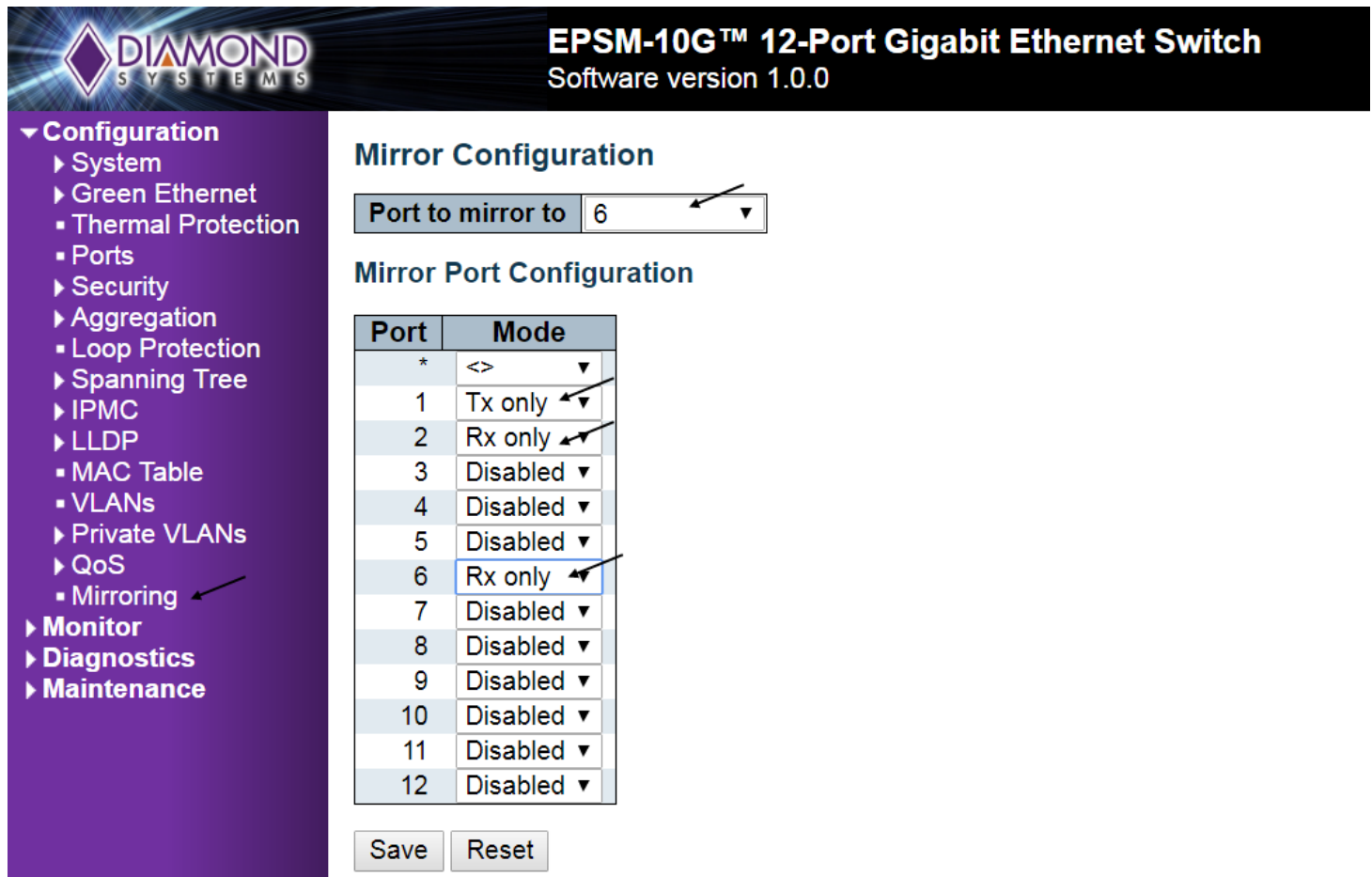

Configuration

- ▶ System
- ▶ Green Ethernet
 - Thermal Protection
 - Ports
- ▶ Security
- ▶ Aggregation
 - Loop Protection
- ▶ Spanning Tree
- ▶ IPMC
- ▶ LLDP
 - MAC Table
 - VLANs
 - ▶ Private VLANs
 - ▶ QoS
 - Mirroring
- ▶ Monitor
- ▶ Diagnostics
- ▶ Maintenance

EPMS-10G™ 12-Port Gigabit Ethernet Switch
Software version 1.0.0

Mirror Configuration

Port to mirror to: 6

Mirror Port Configuration

Port	Mode
*	<>
1	Tx only
2	Rx only
3	Disabled
4	Disabled
5	Disabled
6	Rx only
7	Disabled
8	Disabled
9	Disabled
10	Disabled
11	Disabled
12	Disabled

Save Reset

Figure 19 Mirroring

Other Mirroring options -

The port displaying the mirroring is also known as the mirror port. Frames from ports that have either source (rx) or destination (tx) mirroring enabled are mirrored on this port. Disabled disables mirroring.

Mirror Mode Configuration

1. Rx only - Frames received on this port are mirrored on the mirror port. Frames transmitted are not mirrored
2. Tx only - Frames transmitted on this port are mirrored on the mirror port. Frames received are not mirrored
3. Disabled - Neither frames transmitted nor frames received are mirrored
4. Enabled - Frames received and frames transmitted are mirrored on the mirror port

10.1.7 Setup QoS

Basic QoS classification configuration can be done per port. Ingress traffic coming on each port can be assigned to a QoS class (CoS), PCP, DPL and DEI. The following example depicts the QoS ingress port classification.

All traffic coming on port 3 is mapped to Cos 4 and PCP is set as 1.

Web GUI Configuration: (Navigate to Configuration ->QoS->Port Classification)

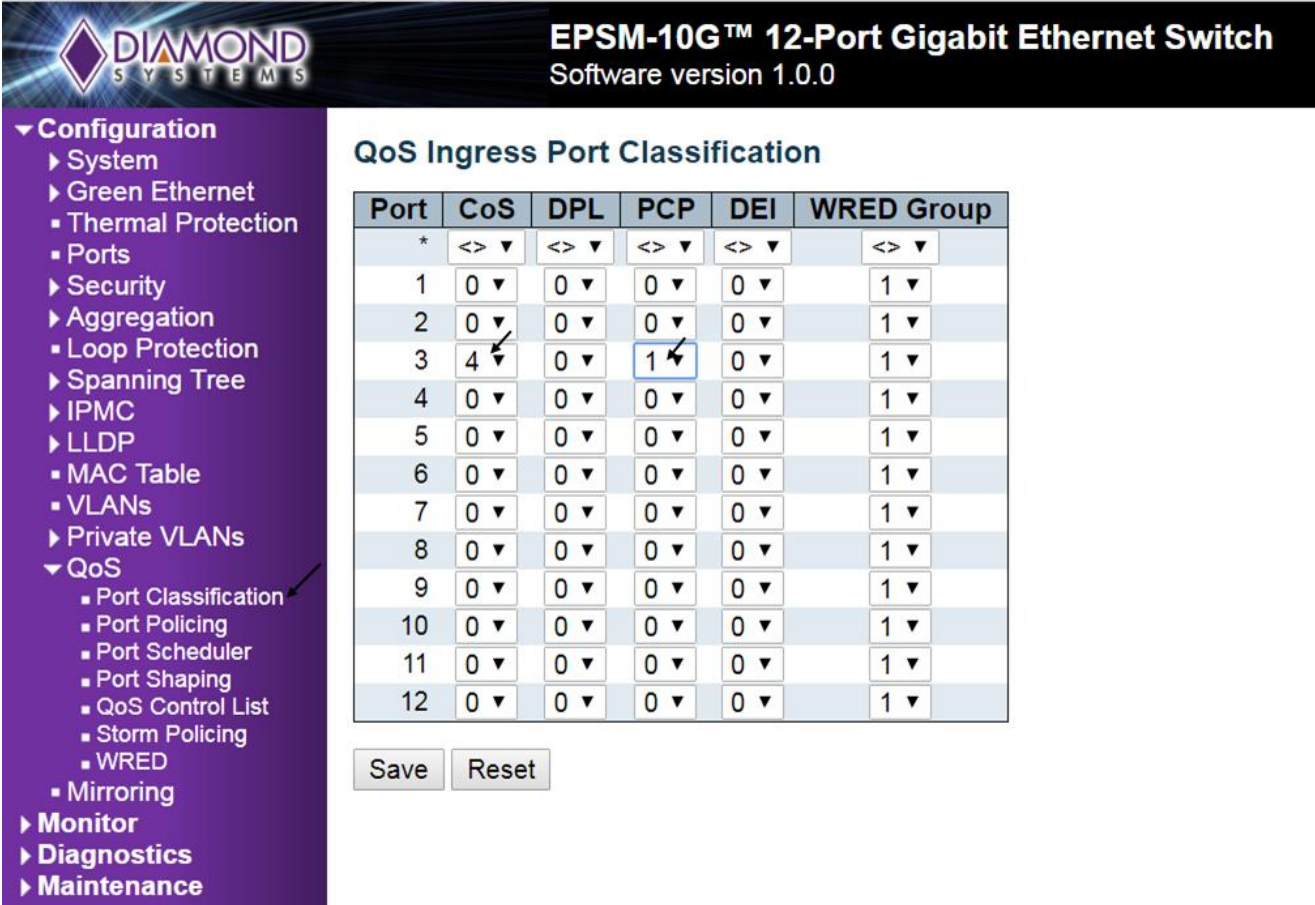

EPISM-10G™ 12-Port Gigabit Ethernet Switch
Software version 1.0.0

QoS Ingress Port Classification

Port	CoS	DPL	PCP	DEI	WRED Group
*	<> ▼	<> ▼	<> ▼	<> ▼	<> ▼
1	0 ▼	0 ▼	0 ▼	0 ▼	1 ▼
2	0 ▼	0 ▼	0 ▼	0 ▼	1 ▼
3	4 ▼	0 ▼	1 ▼	0 ▼	1 ▼
4	0 ▼	0 ▼	0 ▼	0 ▼	1 ▼
5	0 ▼	0 ▼	0 ▼	0 ▼	1 ▼
6	0 ▼	0 ▼	0 ▼	0 ▼	1 ▼
7	0 ▼	0 ▼	0 ▼	0 ▼	1 ▼
8	0 ▼	0 ▼	0 ▼	0 ▼	1 ▼
9	0 ▼	0 ▼	0 ▼	0 ▼	1 ▼
10	0 ▼	0 ▼	0 ▼	0 ▼	1 ▼
11	0 ▼	0 ▼	0 ▼	0 ▼	1 ▼
12	0 ▼	0 ▼	0 ▼	0 ▼	1 ▼

Save Reset

Figure 20 QoS

10.1.8 Web Interface Activation / Deactivation

The web interface can be activated and deactivated through either the command line interface or the web Control Panel.

Using the Control Panel, in the Configuration/Security/Switch/Access Management Configuration screen, first ensure the mode is set to Disabled as shown below. This is the default mode. If it is not set to Disabled, set it as Disabled and click Save.

This configuration should be stored on the switch with the following CLI command:

#copy startup-config flash:{filename}

To disable web access of the switch, in the Control Panel navigate to the Configuration/Security/Switch/Access Management Configuration screen, change the mode to Enabled and click Save.

Now there is no access to the switch using the web interface. To store this configuration in flash as the standard configuration on startup, enter the following command in the CLI:

#copy running-config startup-config

To allow web access of the switch in the future, enter the following commands in the CLI:

#copy startup-config flash:backup_config

#copy flash:{filename} startup-config

Then reboot the switch.

10.1.9 Firmware upgrade

The following section describes the steps necessary for upgrading the firmware:

1. Connect to the web interface of EPS-12000-CM switch and navigate to Maintenance -> Software -> Upload
2. Choose the file to be uploaded and click on Upload.

Existing firmware shall be erased and new firmware is loaded, once the upgrade completes, the switch reboots automatically.



Figure 21 Firmware Upload

10.1.10 Save Startup configuration

This copies running-config to startup-config, thereby ensuring that the currently active configuration will be used at the next reboot. The following example describes saving the startup configuration:

3. Connect to the web interface of EPS-12000-CM switch
4. Navigate to Maintenance -> Configuration -> Save Startup-Config
5. Click on Save Configuration



Figure 22 Save startup configuration

10.1.11 Factory defaults

The user can reset the configuration of the switch on this page. Only the IP configuration is retained. The new configuration is available immediately. The following procedure describes the steps for resetting the factory defaults:

1. Connect to the web interface of EPS-12000-CM switch
2. Navigate to maintenance -> Factory defaults
3. Click on Yes for a confirmation message

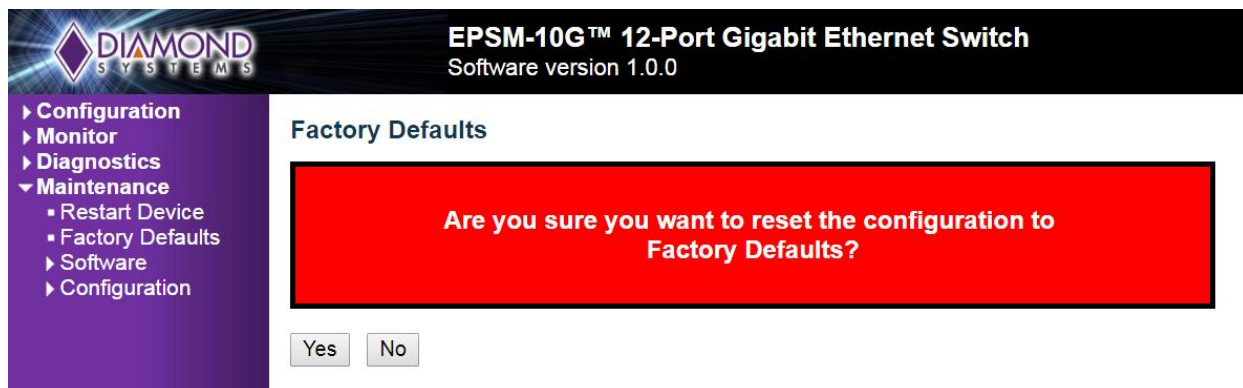

Figure 23 Factory Defaults

SPECIFICATIONS

The specifications for EPSM-10GX are summarized in the following table.

Switch Type	12 port Layer 2+ switch
Number of Ports	12 10/100/1000Mbps Ethernet ports with non-blocking wire-speed performance
On-board Memory	4Mb packet memory Shared memory buffer with per-port & CoS memory management
MEF	Hierarchical MEF compliant policing & scheduling MEF E-Lane, E-Line, and E-Tree services
Frame Buffer	Jumbo frame support at all speeds
VLAN	IEEE 802.1Q VLAN switch with 8K MACs and 4K VLANs Push/pop up to two VLAN tags Independent & shared VLAN learning (IVL, SVL)
Multicast	IPv4 and IPv6 multicast group support
Remarking	Dual leaky bucket policers with remarking and statistics
Classifier	8 priorities and 8 CoS queues per port with strict or deficit-weighted round robin scheduling Shaping/policing per queue and per port
Storm Control	Policing with storm control and MC/BC protection
Link Aggregation	IEEE 802.3ad
Security	Advanced security and prioritization available through multistage TCAM engine
RSTP	Rapid Spanning Tree Protocol (IEEE 802.1W) and MSTP
MIBs	Support for both WebStax and CEServices MIBs
Power Management	ActiPHY and PerfectReach power management VeriPHY cable diagnostics
Serial Port	1 RS-232 port for host interface
Standalone Capable	Standalone network switch, or in combination with a host computer